

1. Vessel Profile

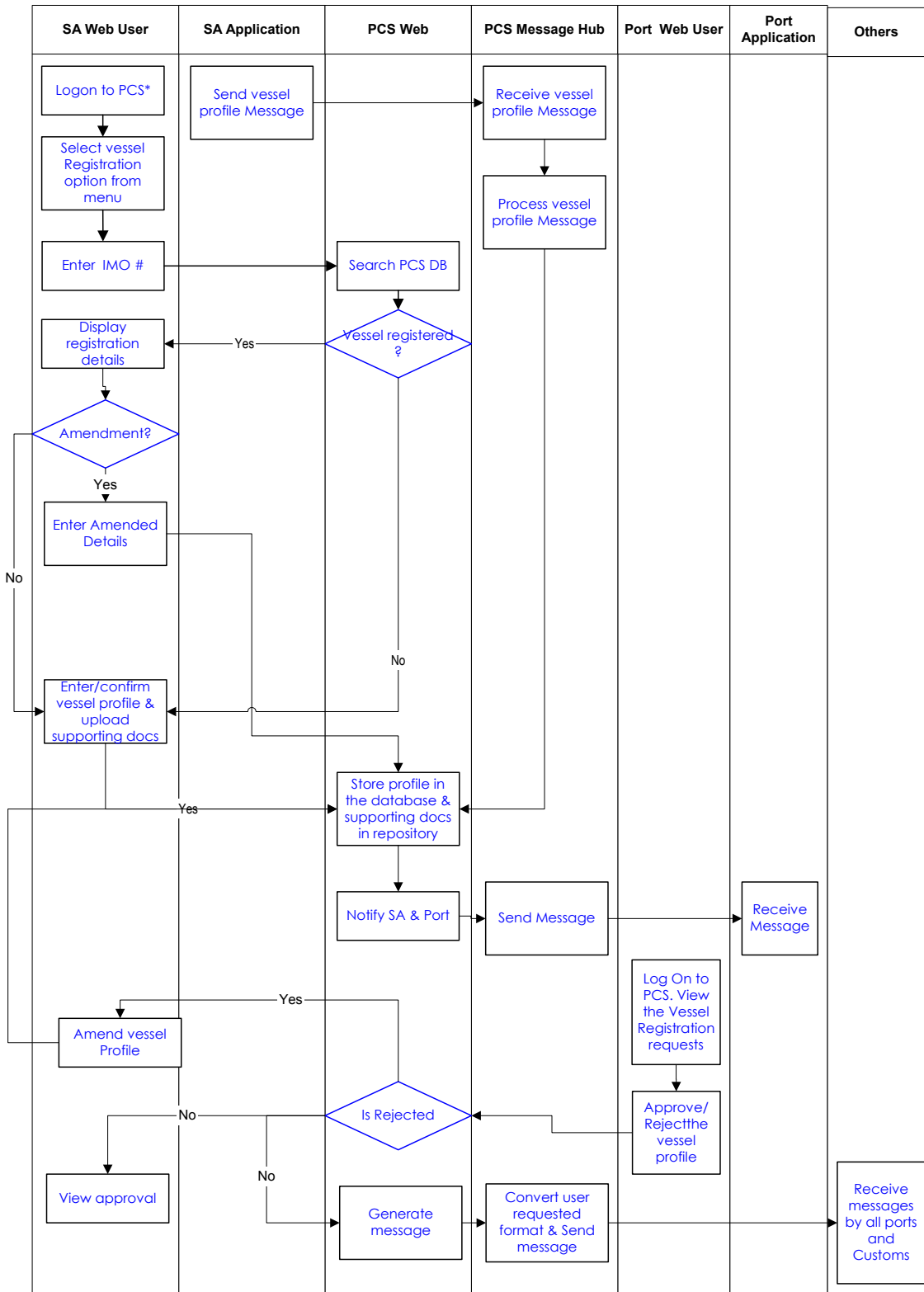

2. Voyage Registration

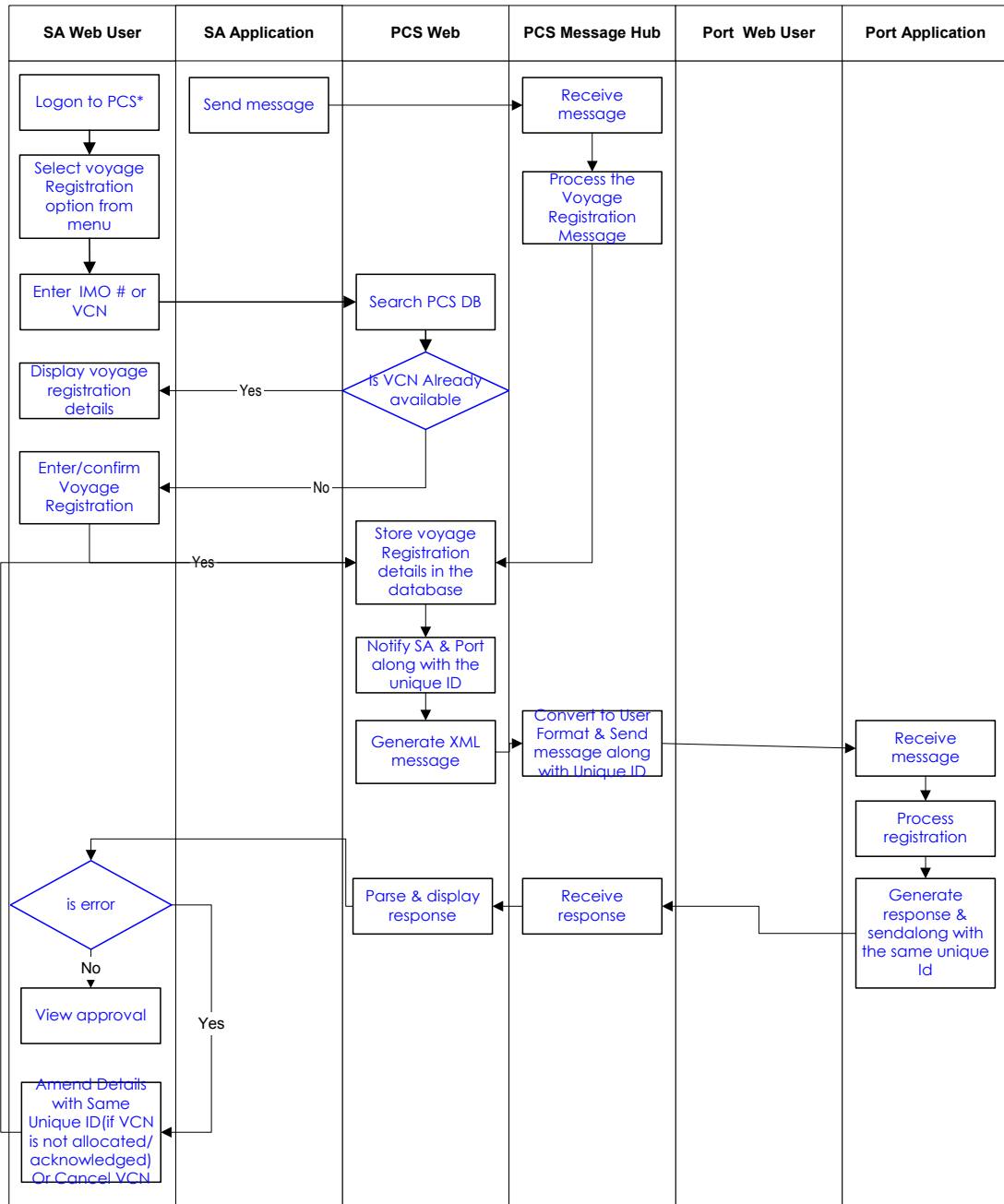

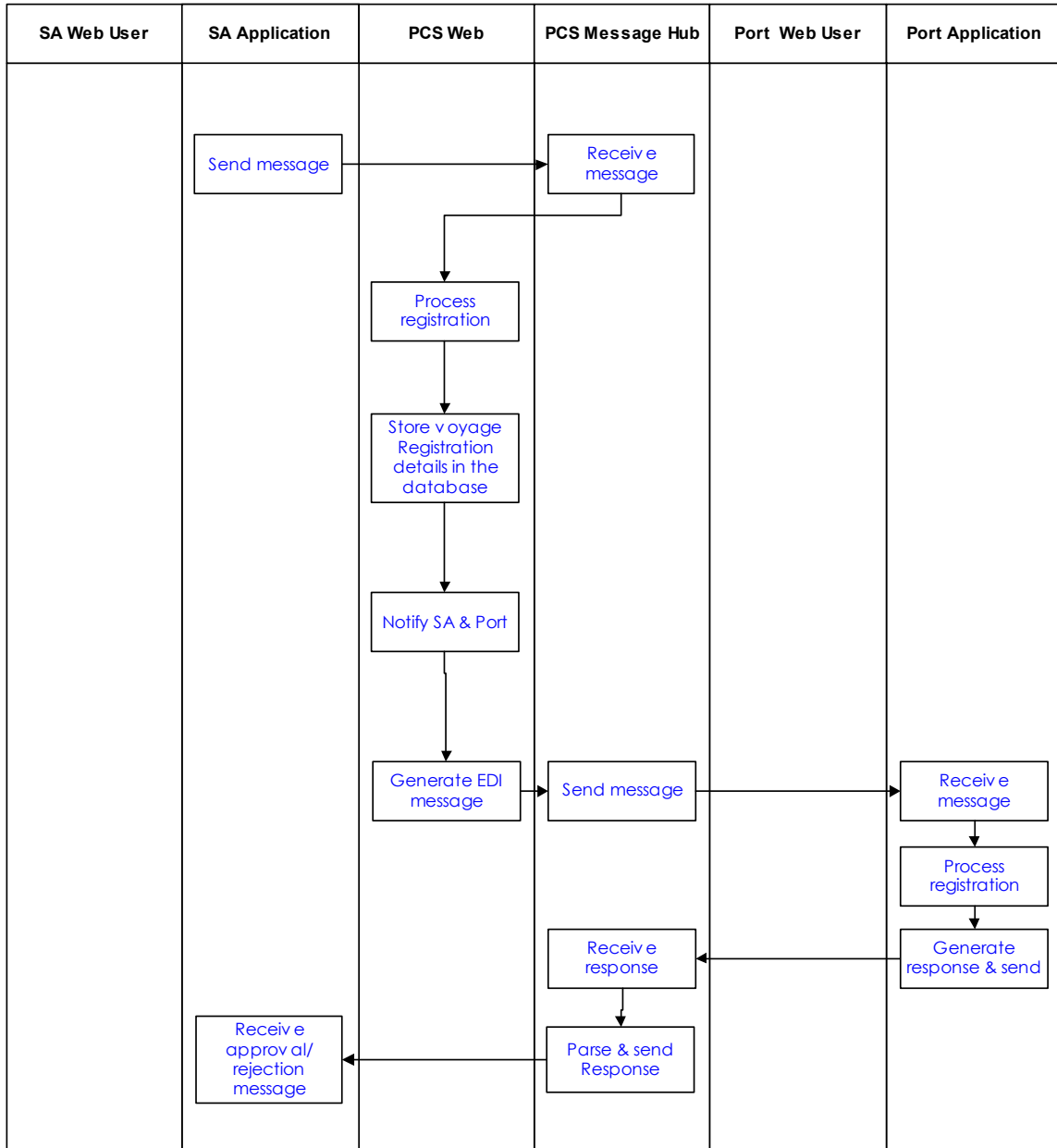

3. Berthing Application

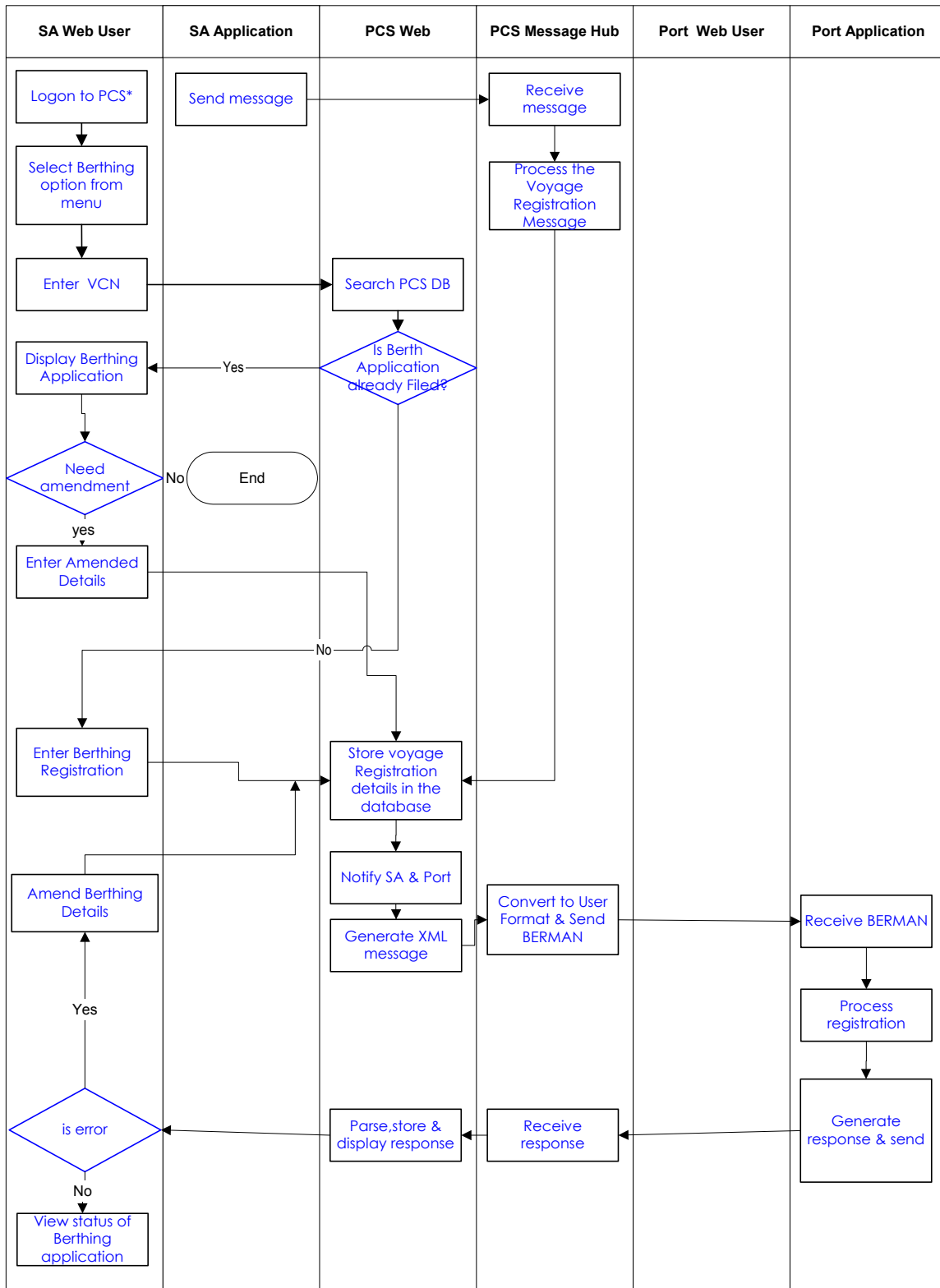

4. Passenger / Crew List

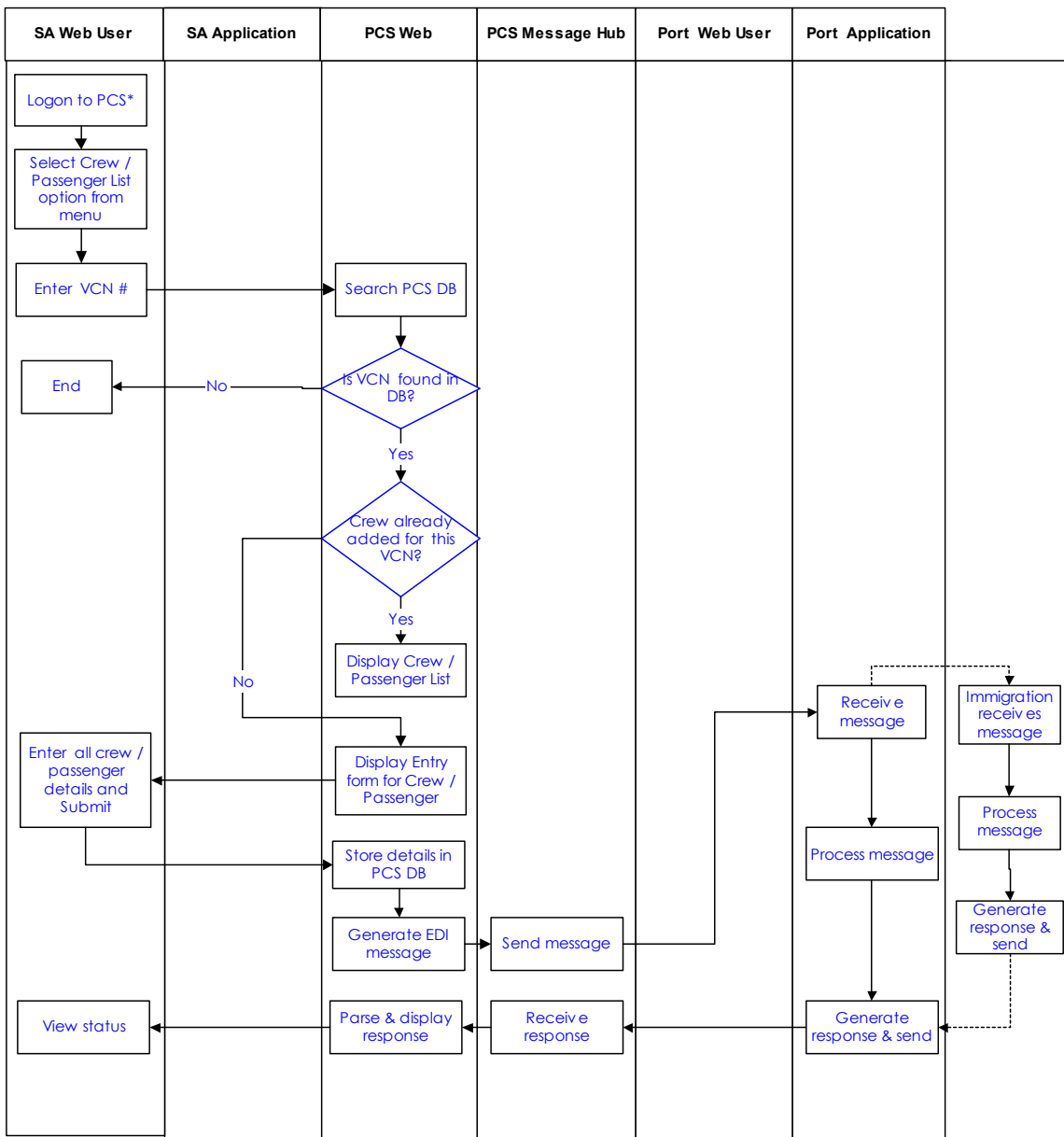

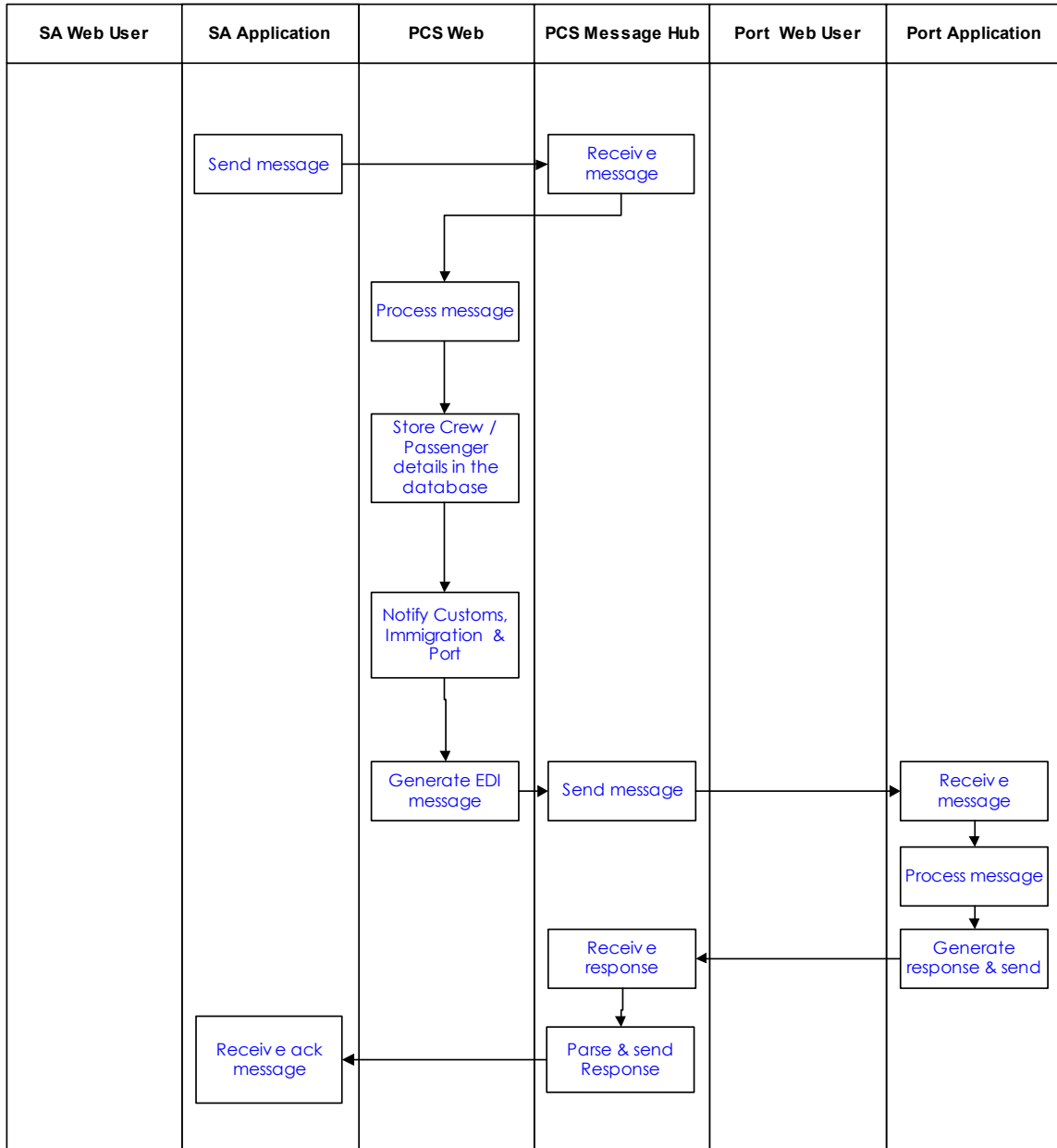

5. Bay Plan –In

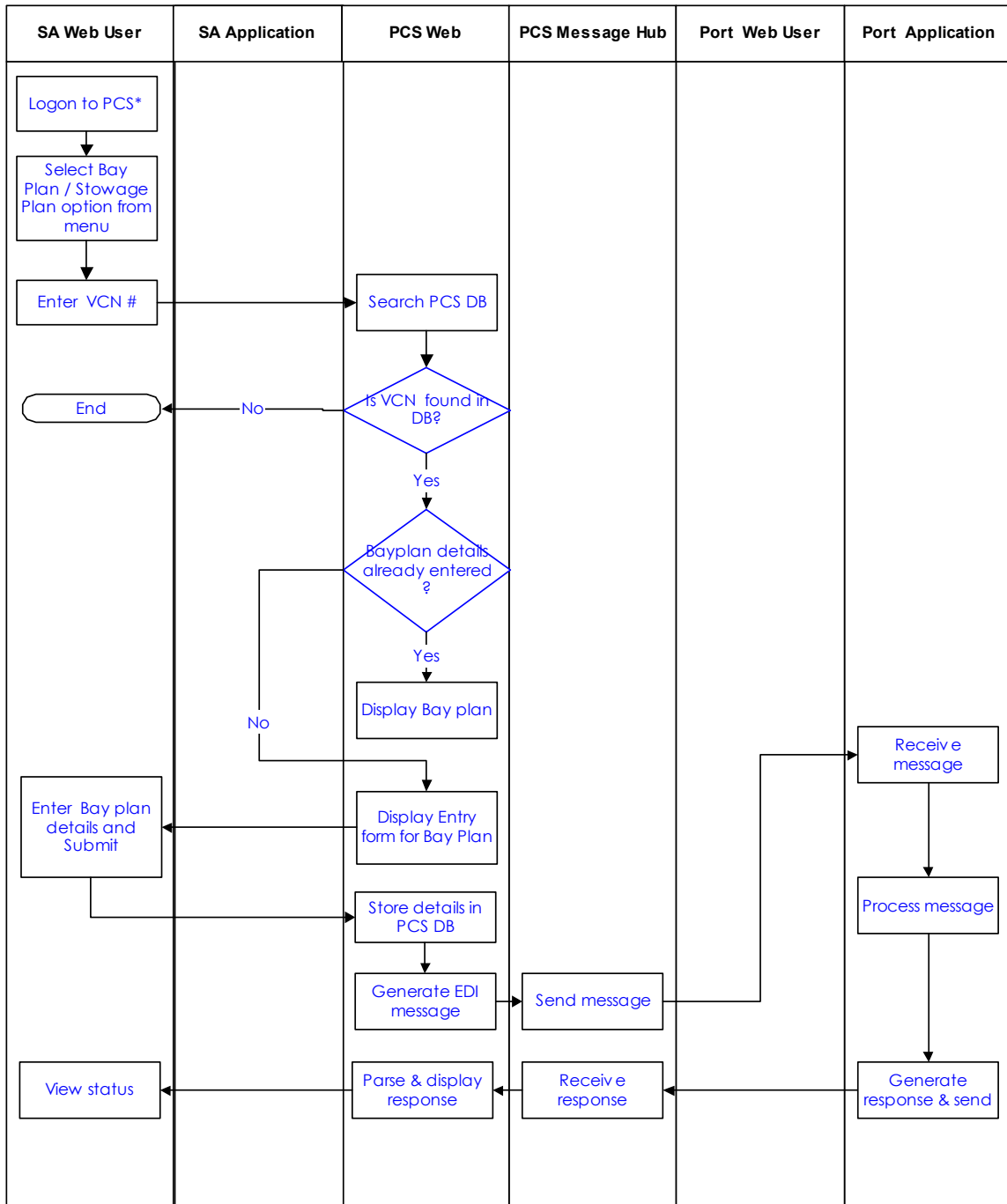

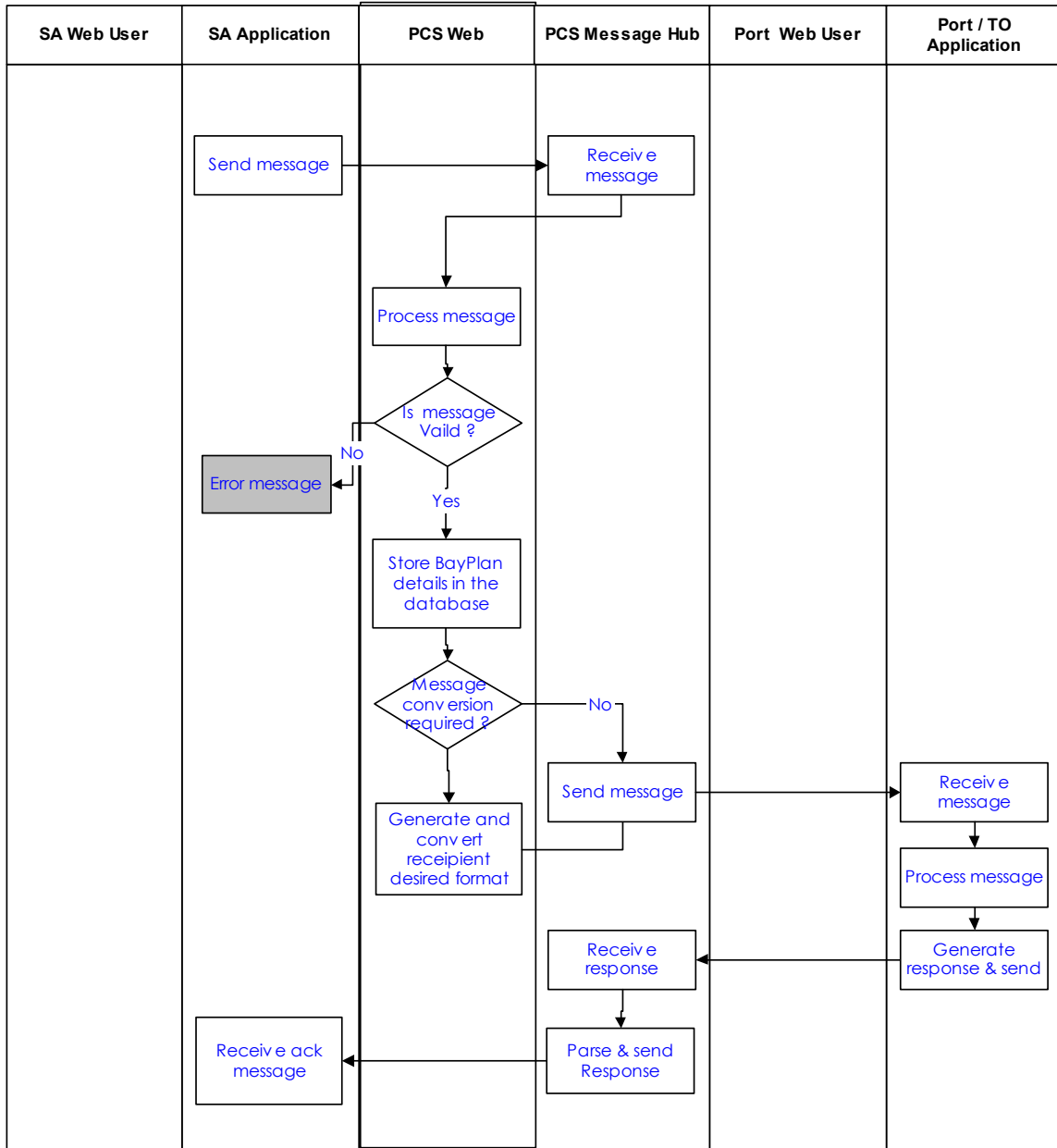

6. Bay Plan – Out

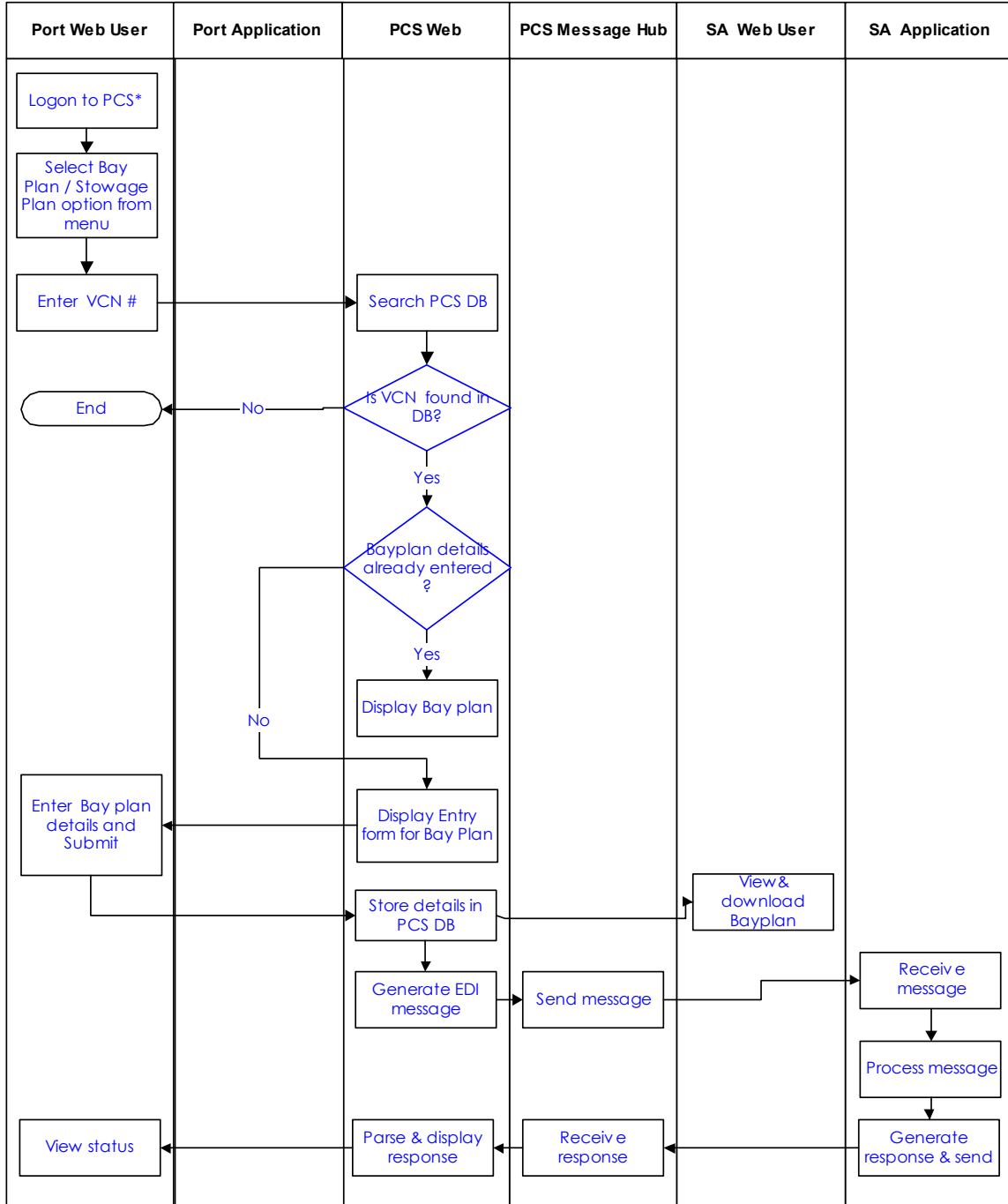

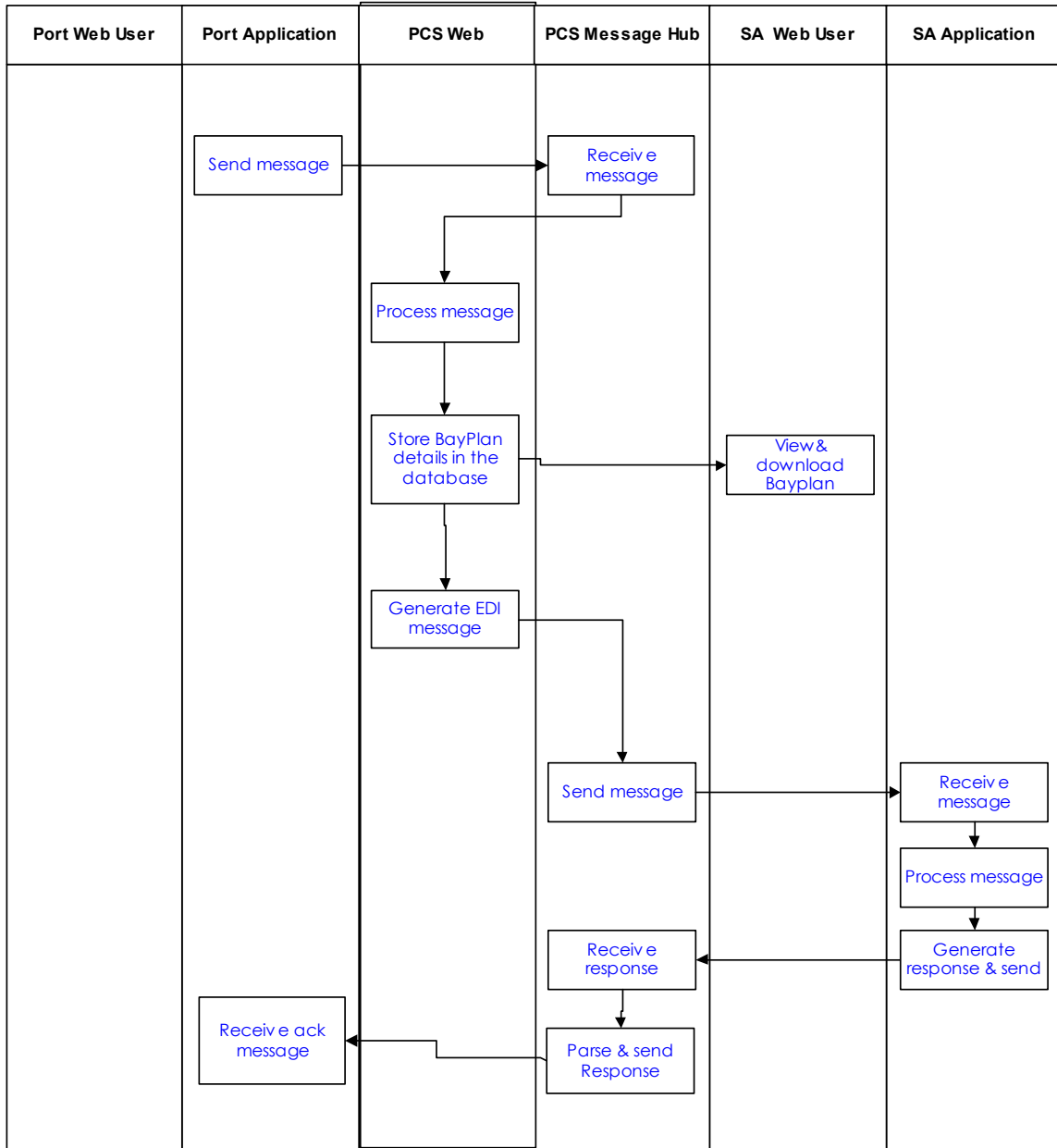

7. Stowage Instruction

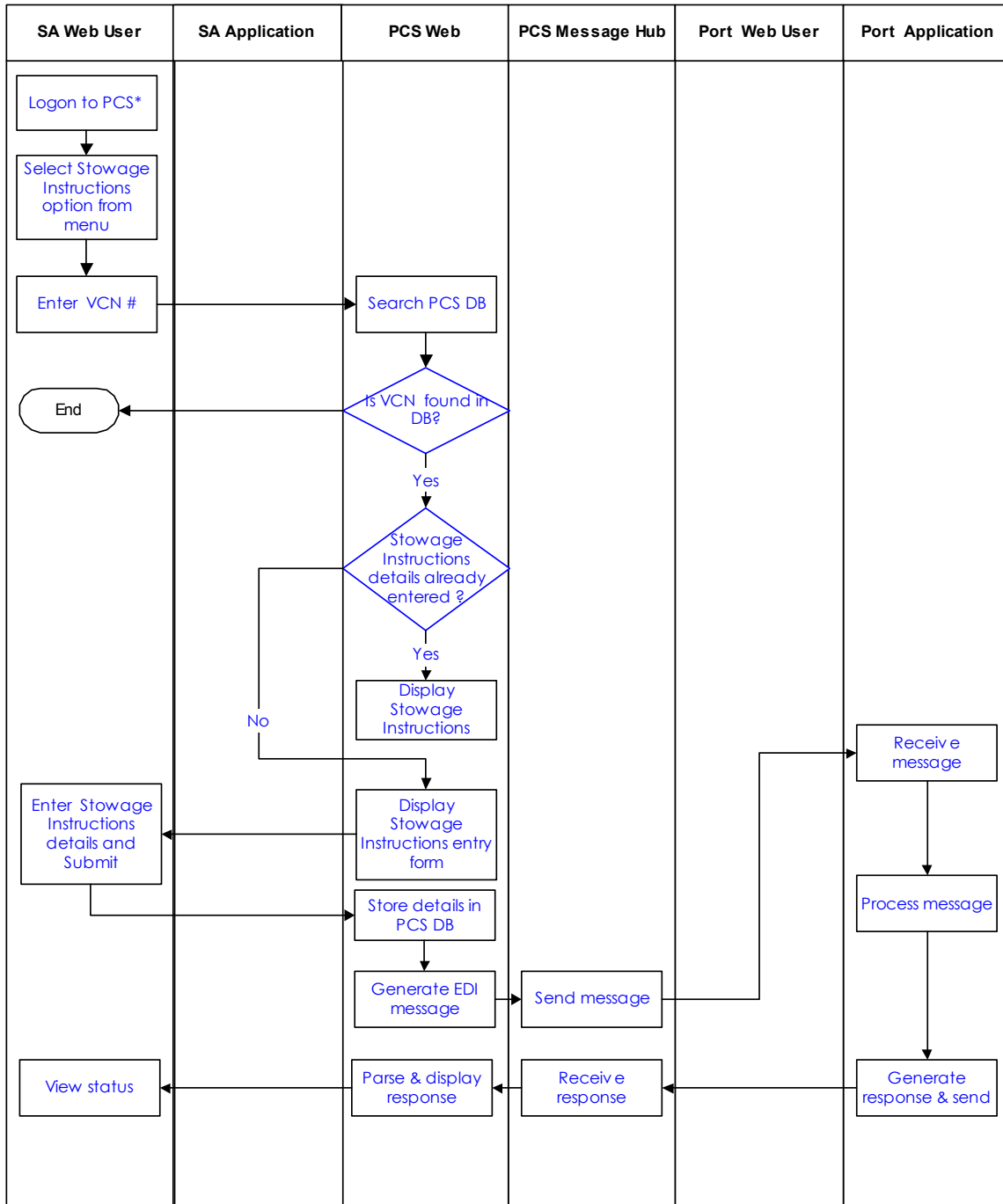

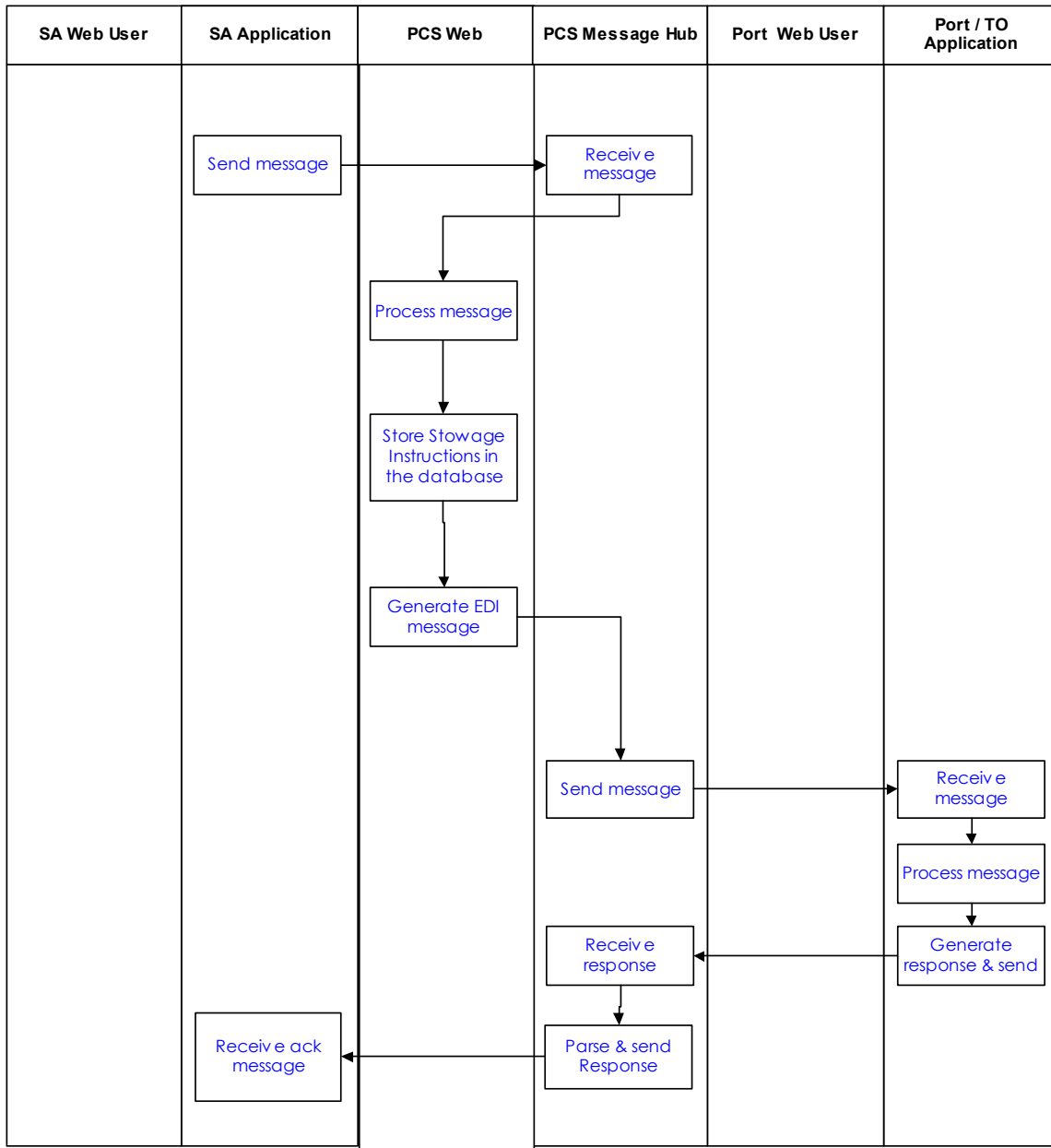

8. Dangerous Goods Notification

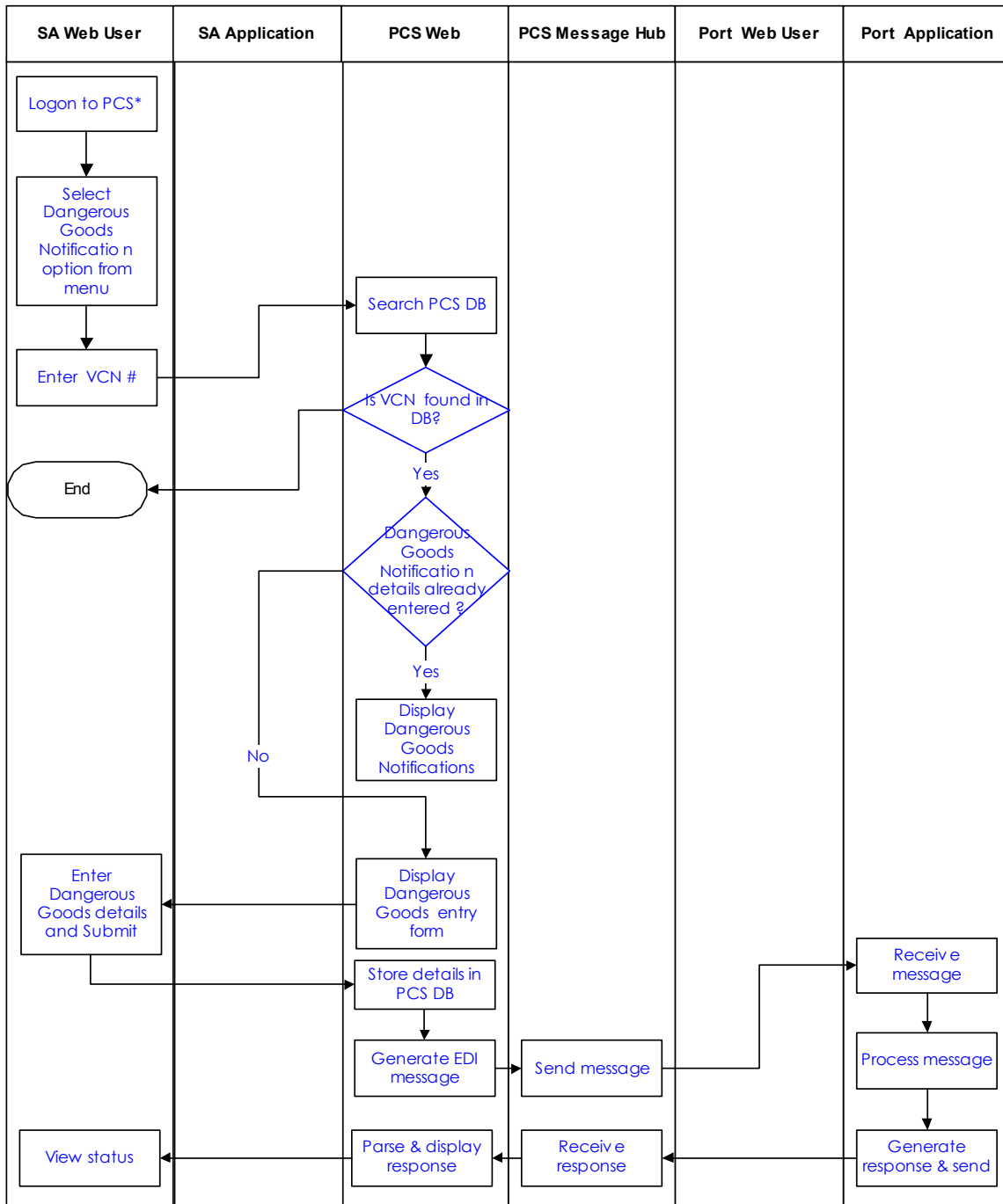

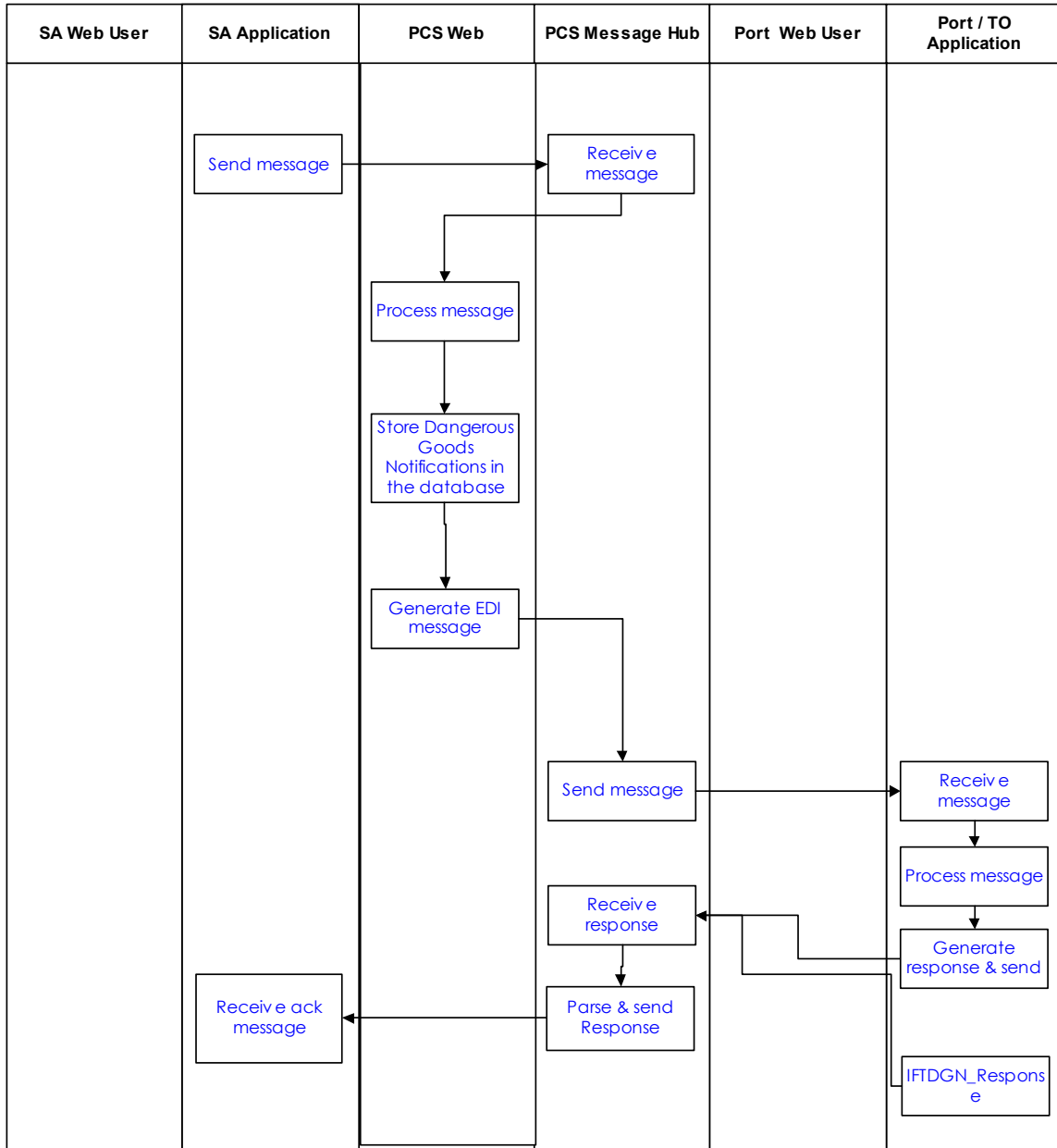

9. Requisition of Resources

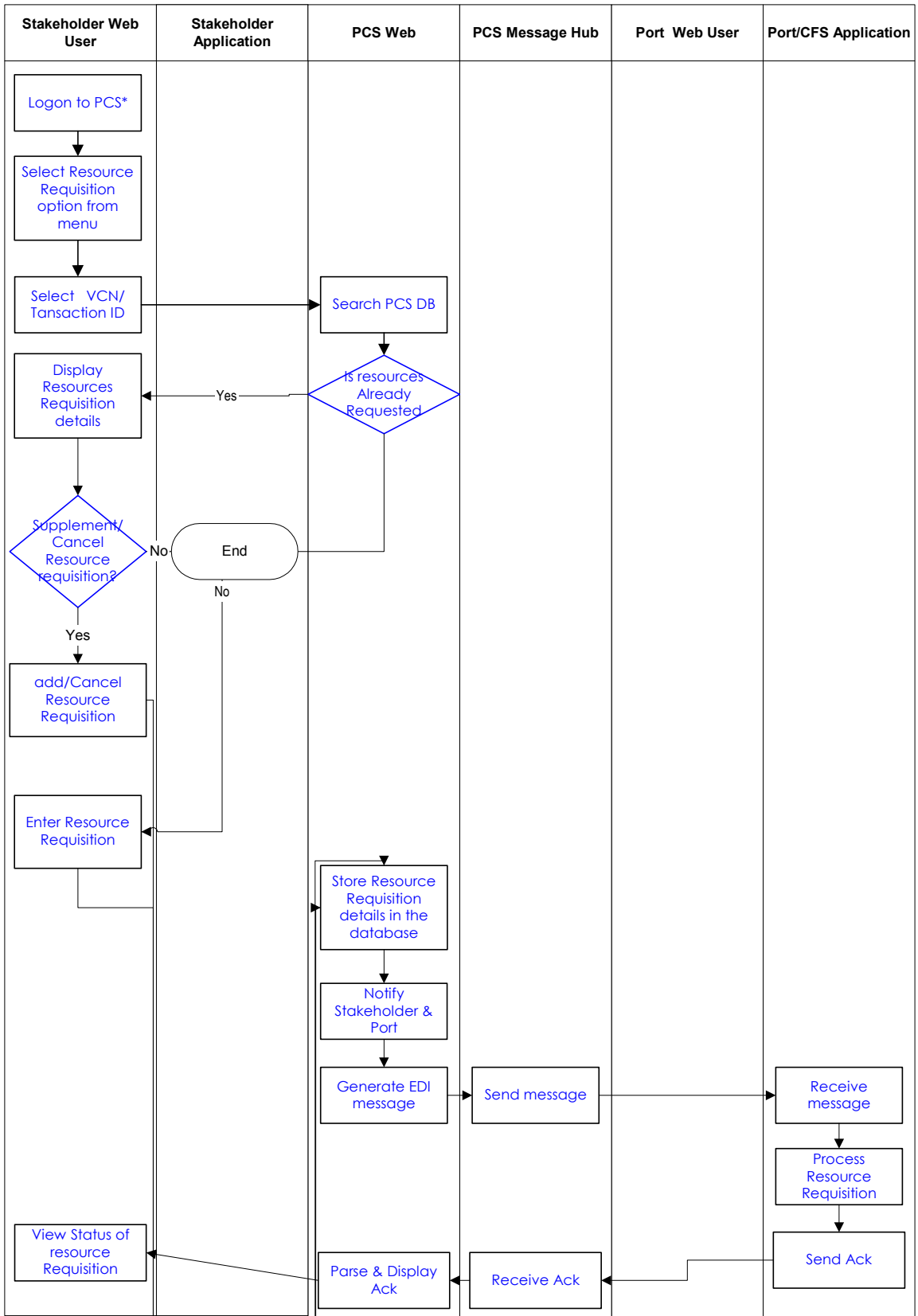

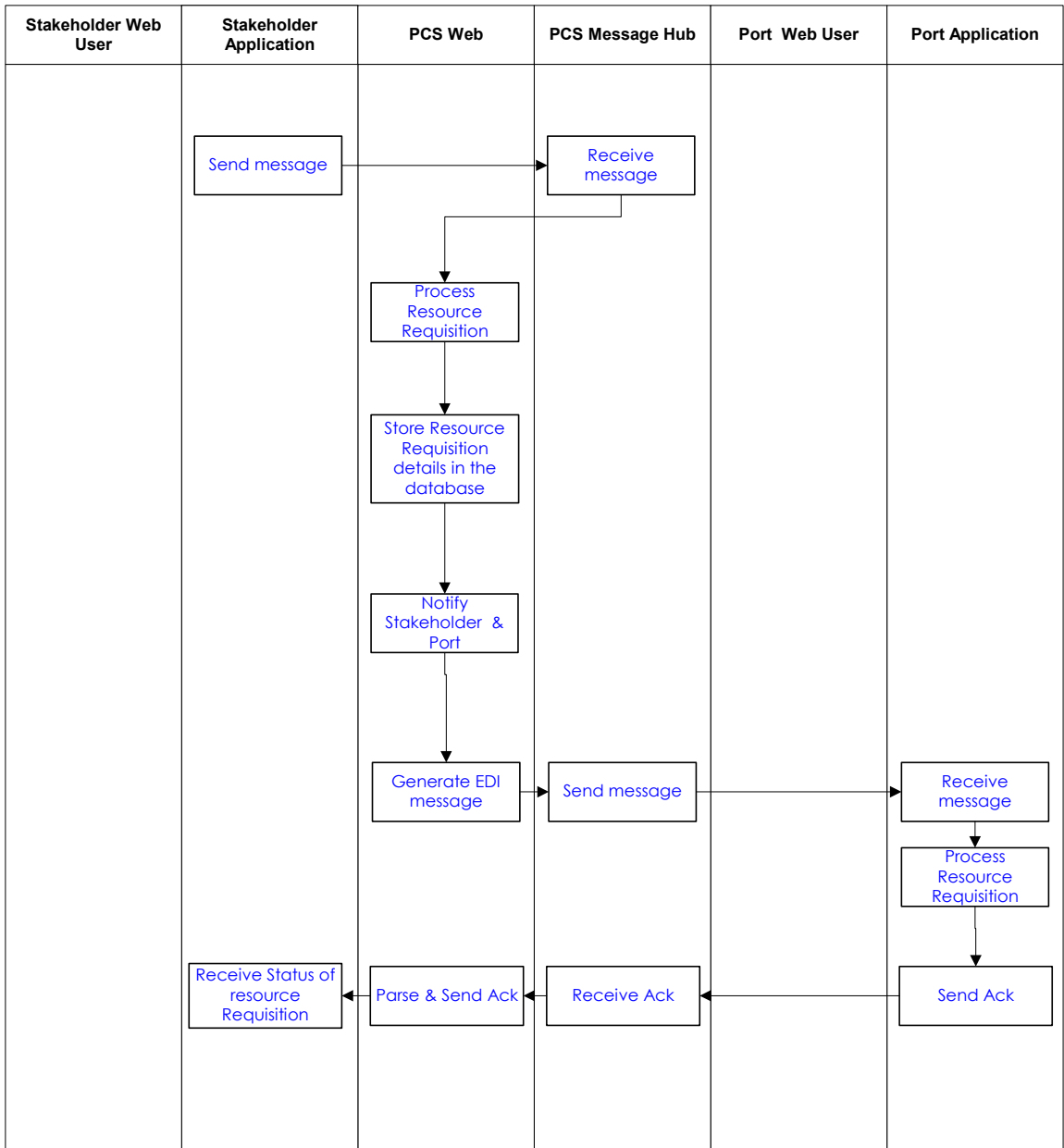

10. Allotment of resources

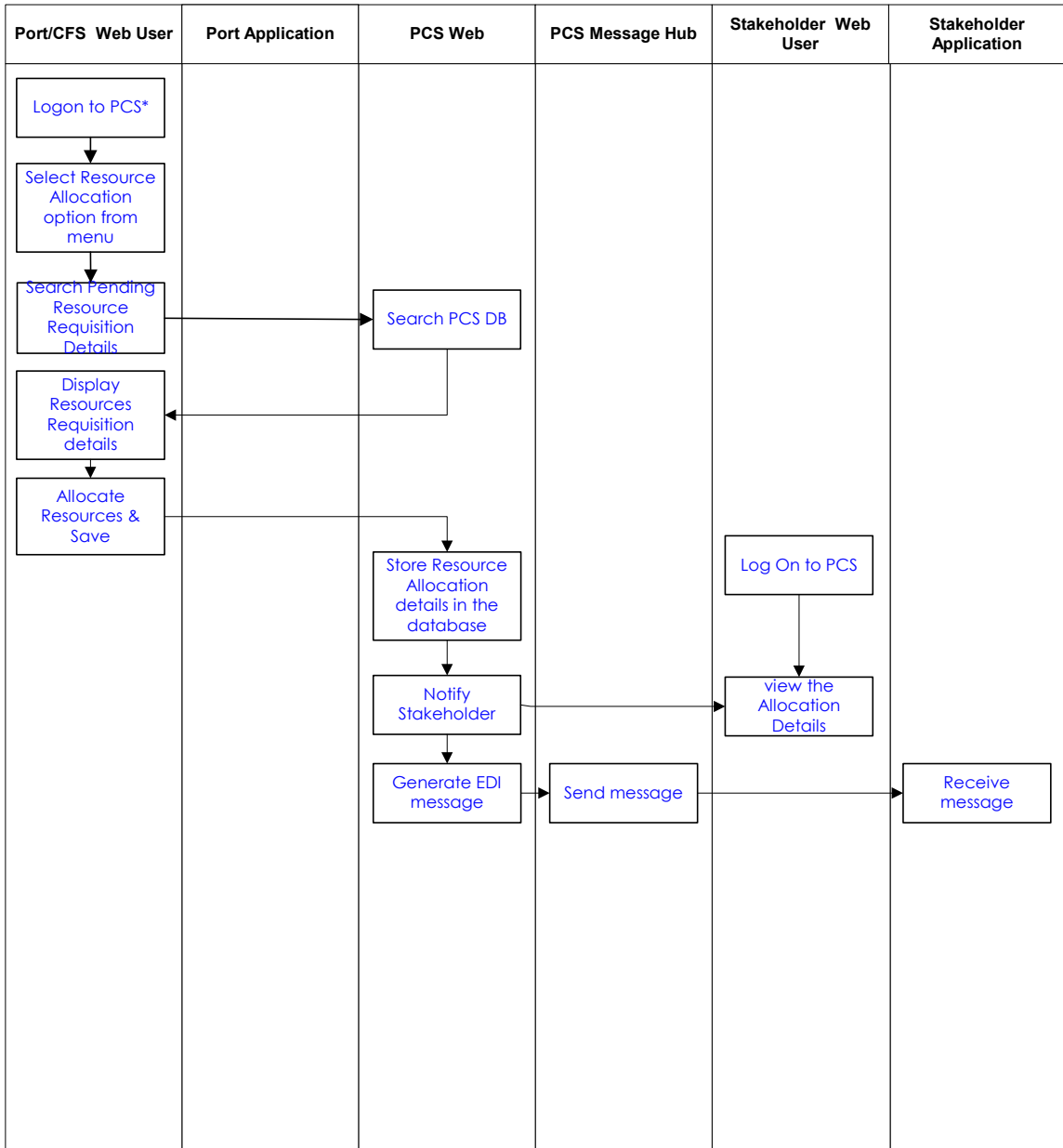

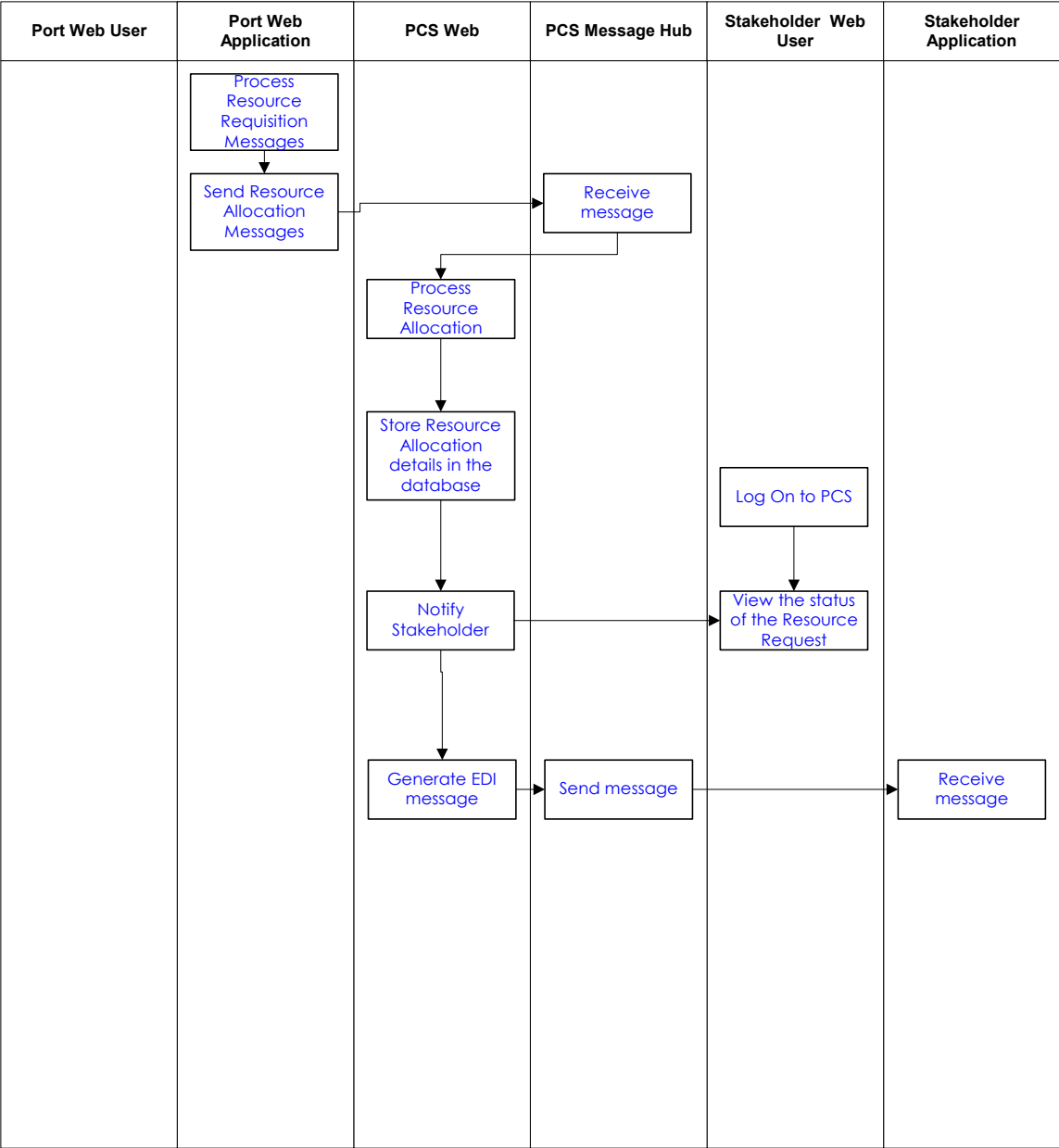

11. Un-Berthing/Sailing/Shifting/Re-Berthing Application

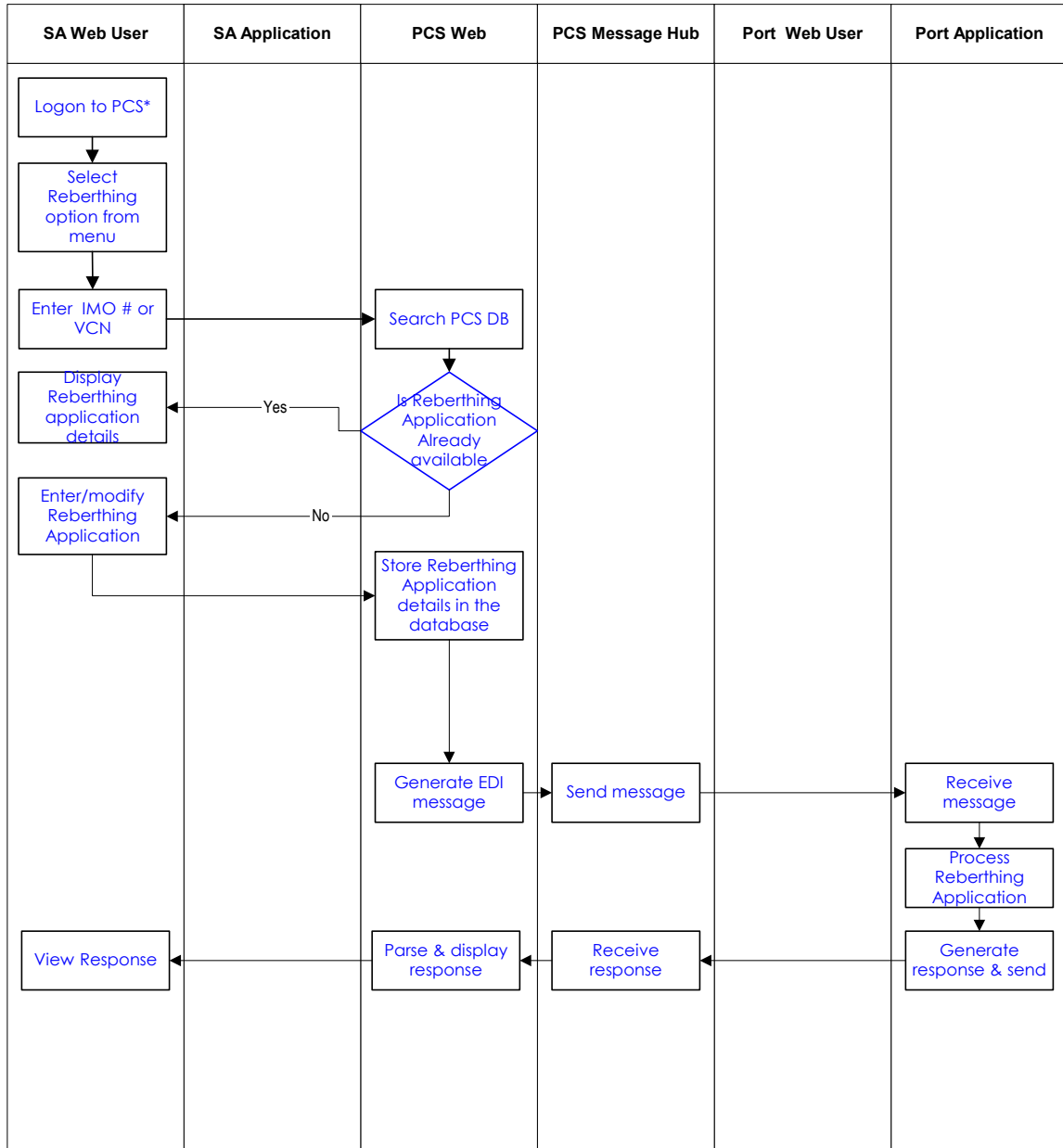

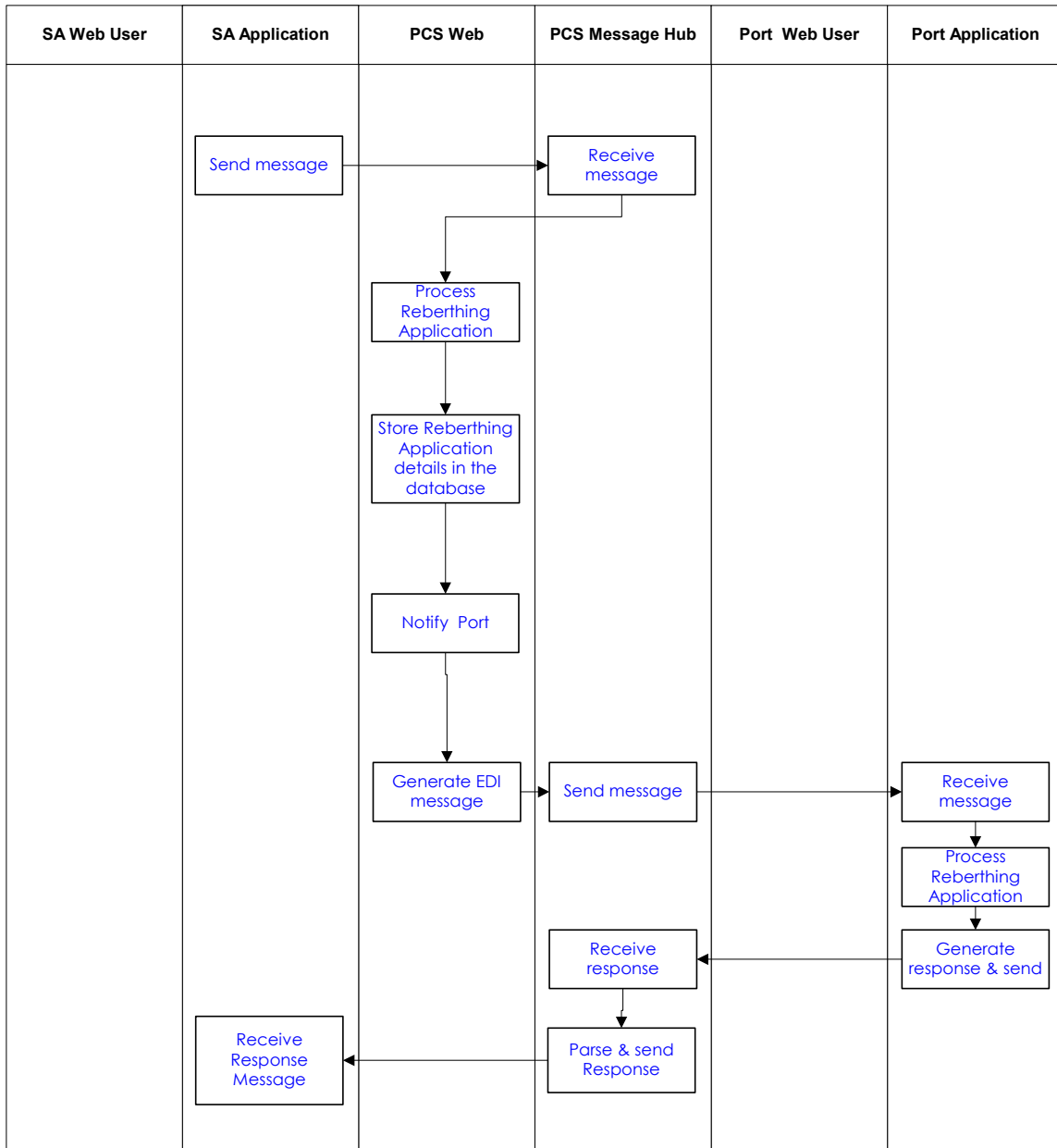

12. Vessel Movement / Vessel Departure Message

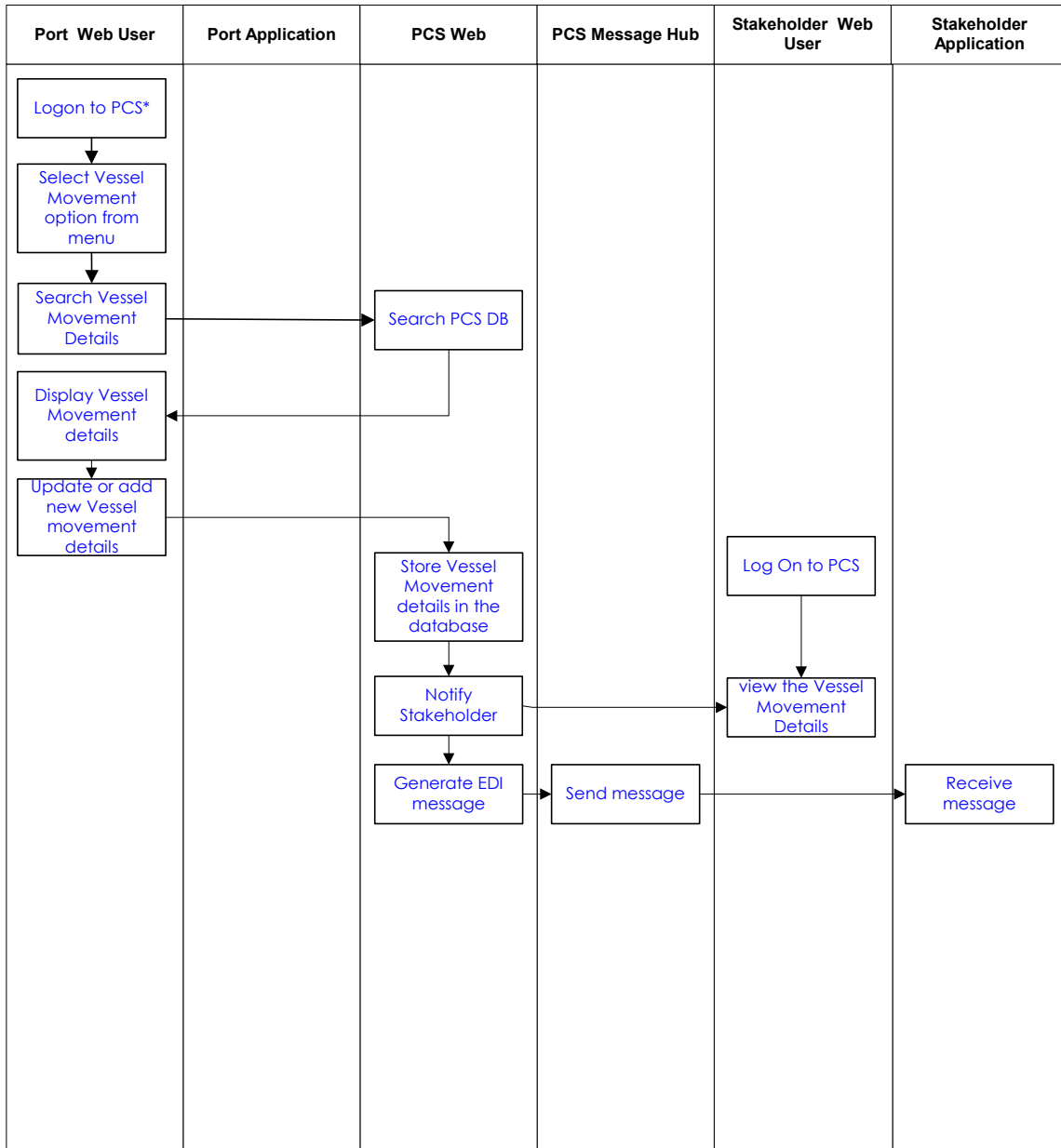

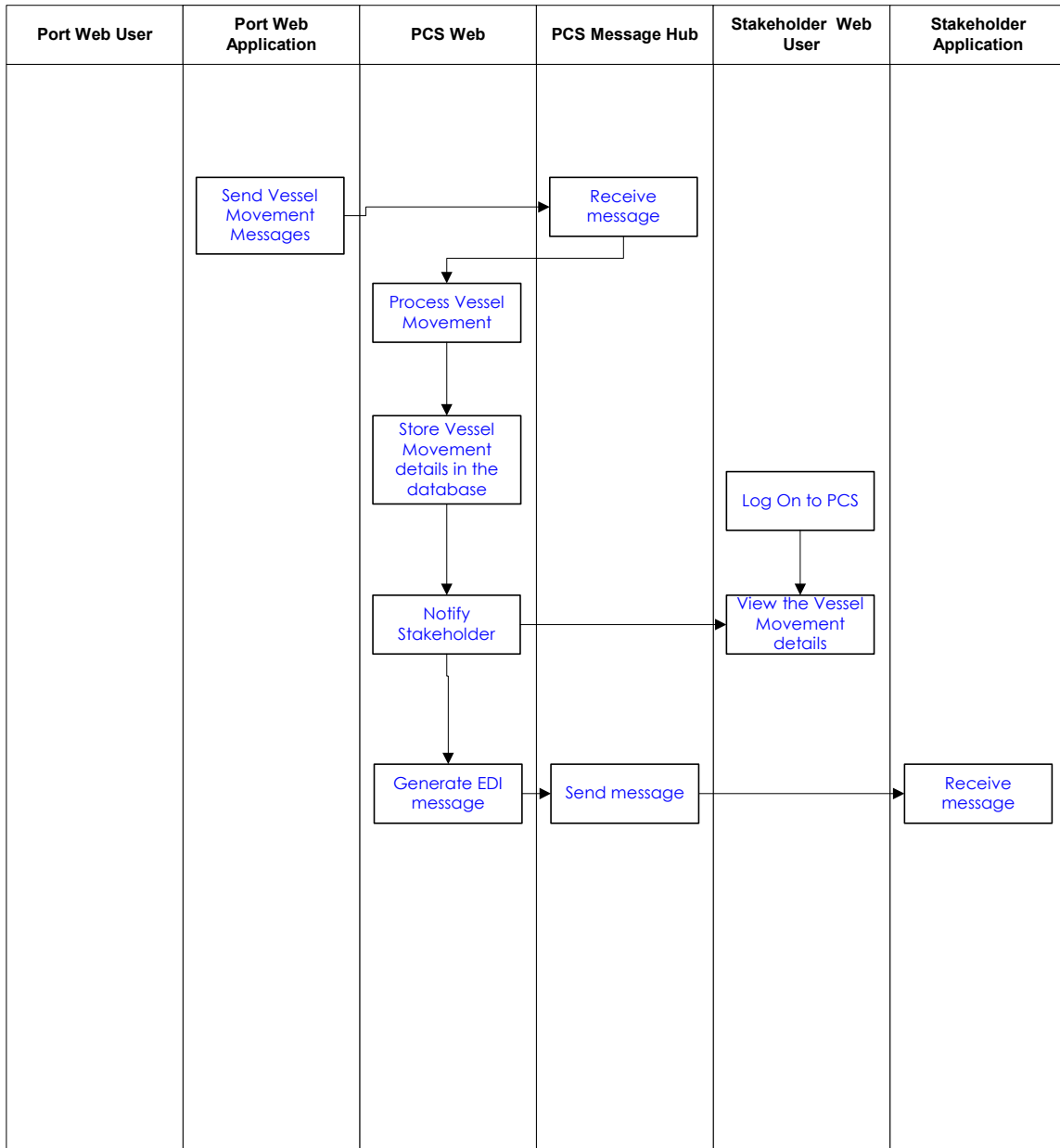

13. Container Loading and Discharge Order/Adv. Container List/Confirmation List

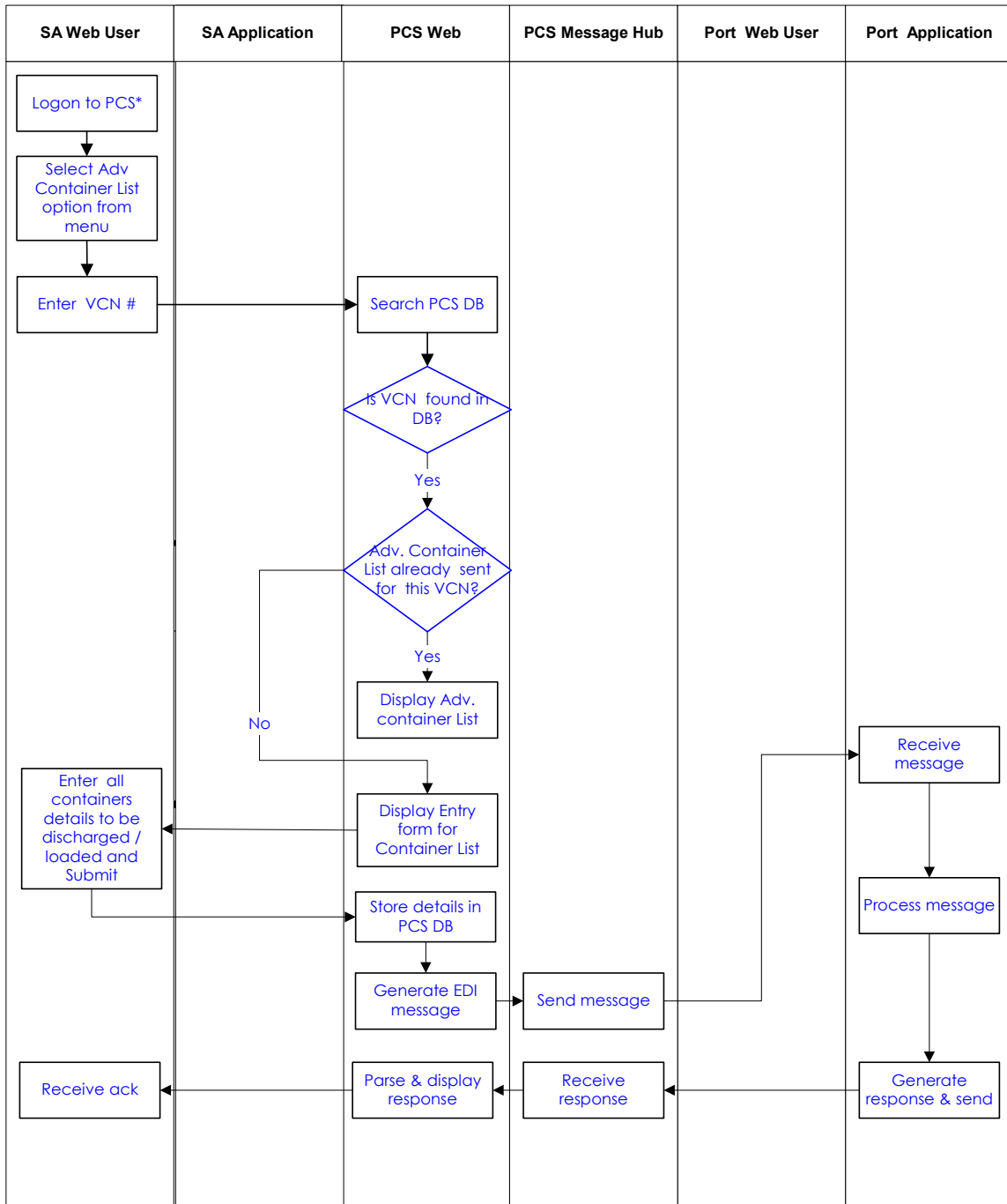

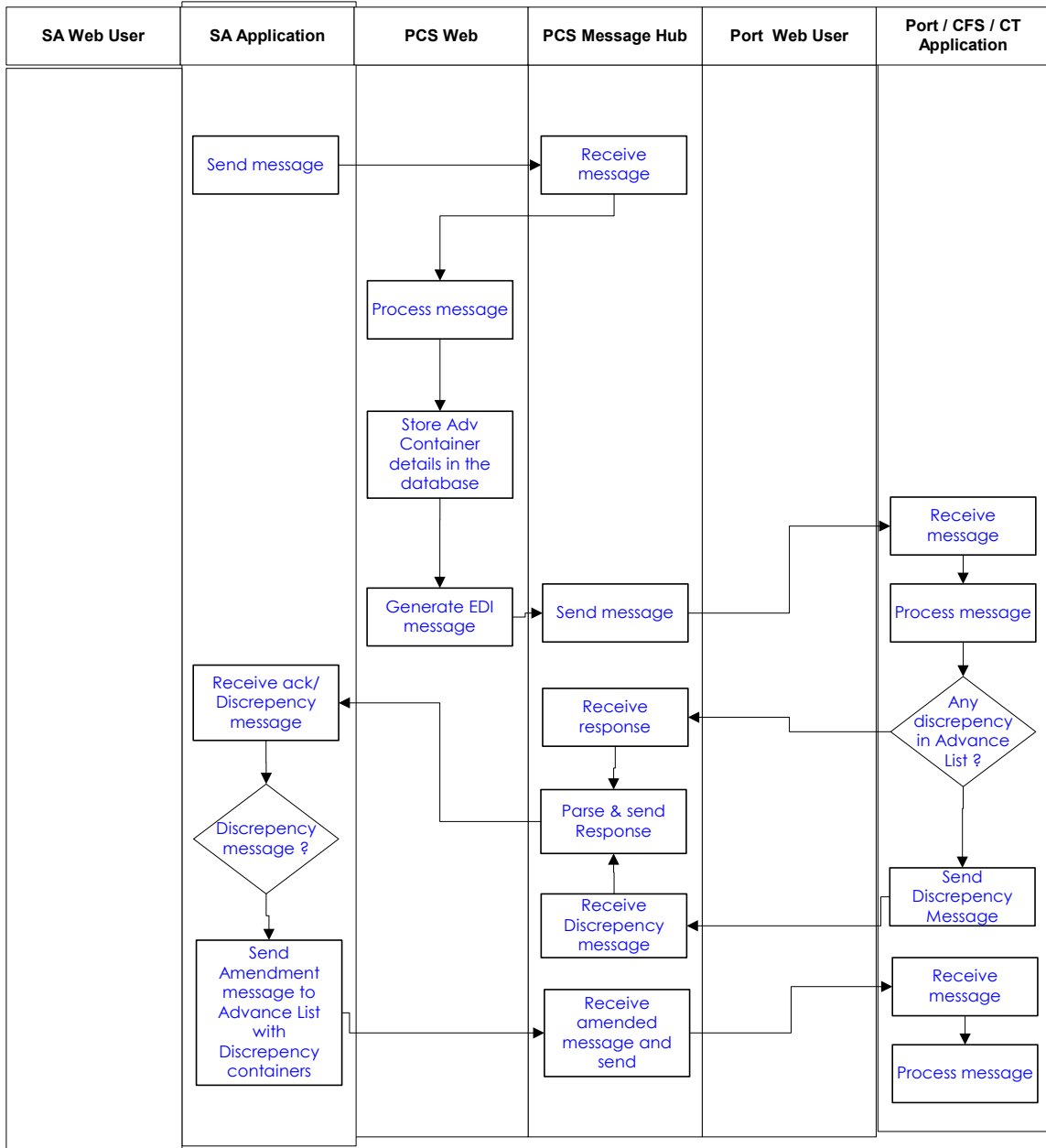

14. Container Loading/Discharge Report

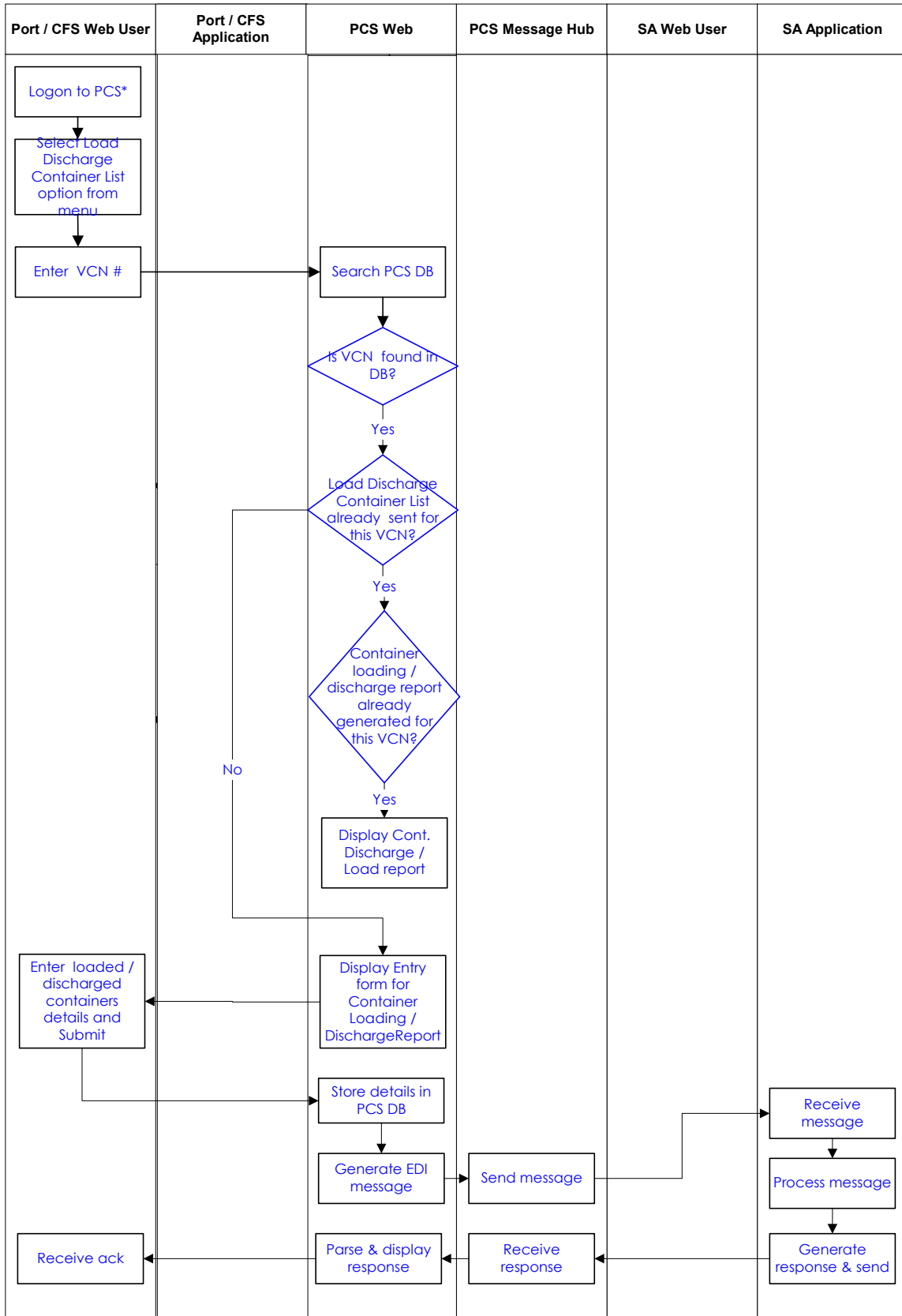

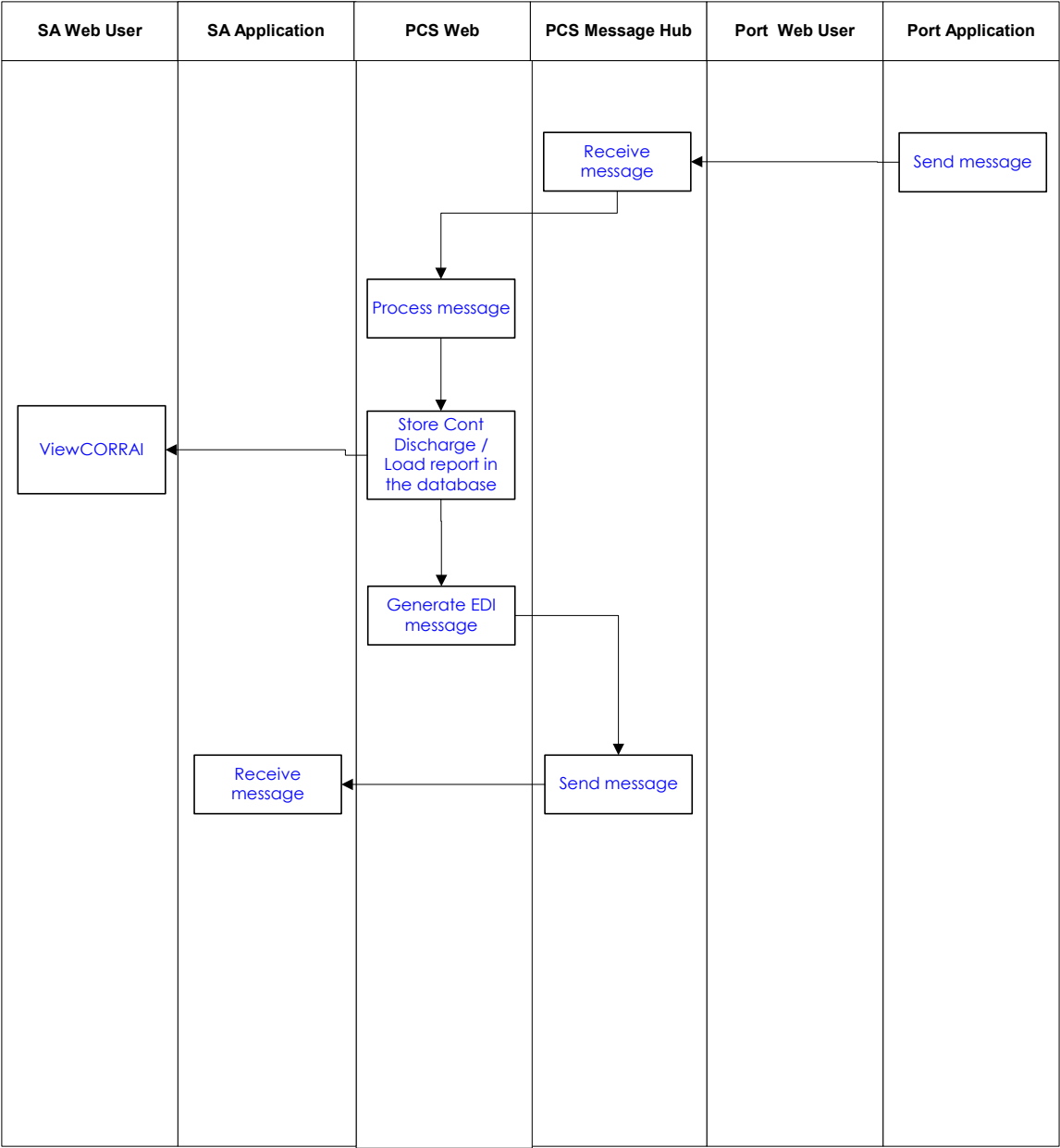

15. Container Stuffing/De-Stuffing

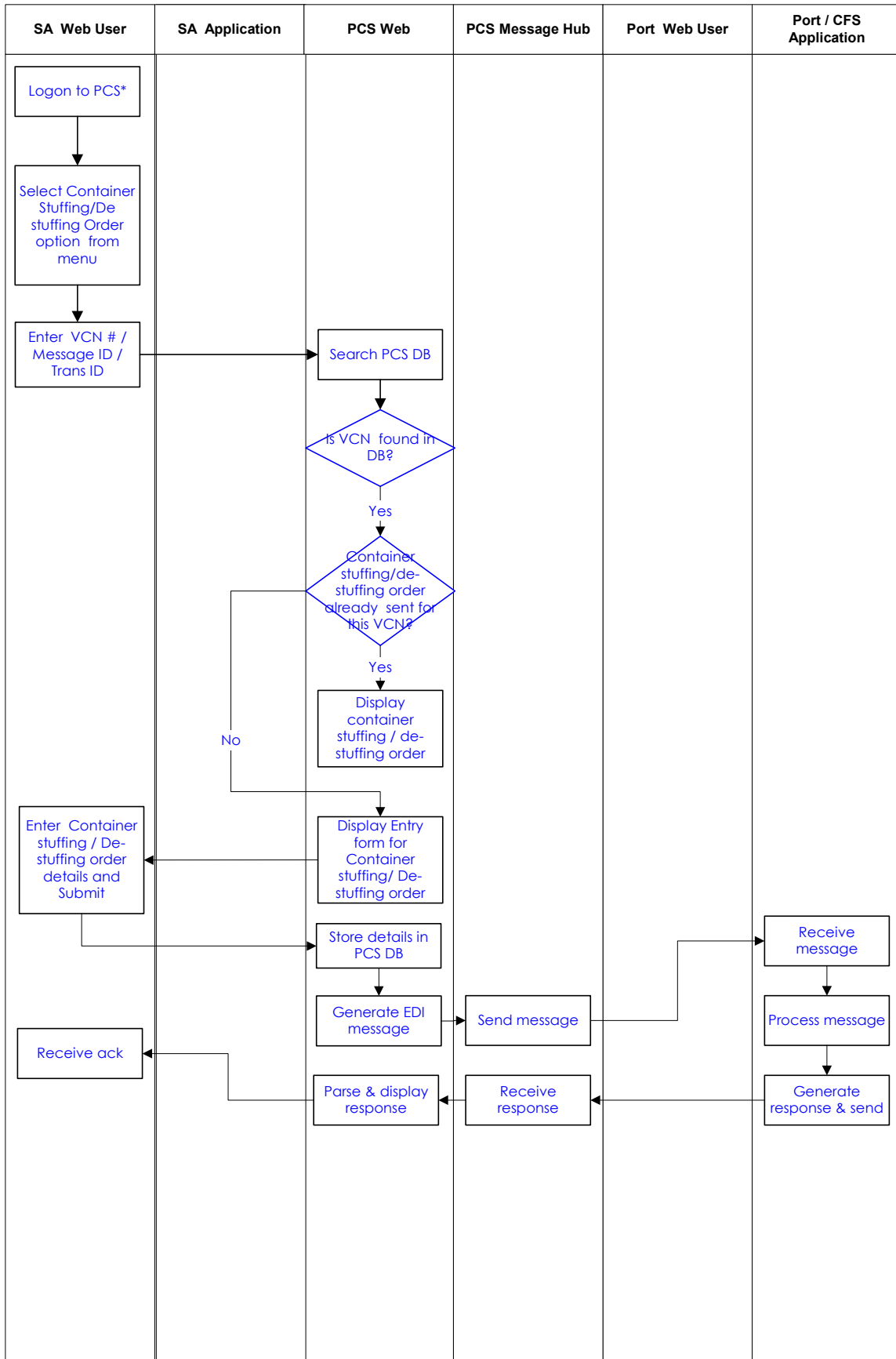

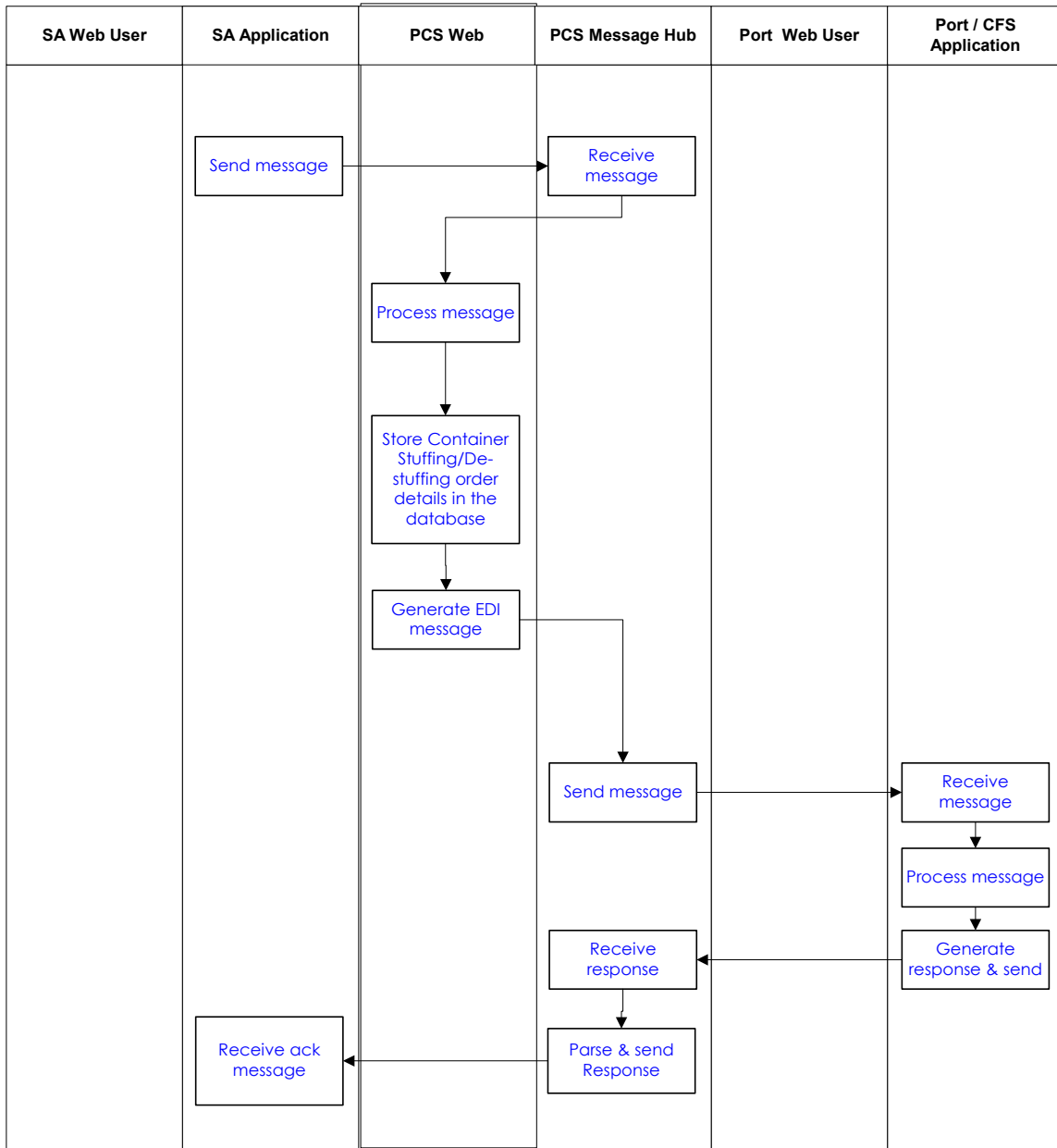

16. Container Load Plan (CLP)

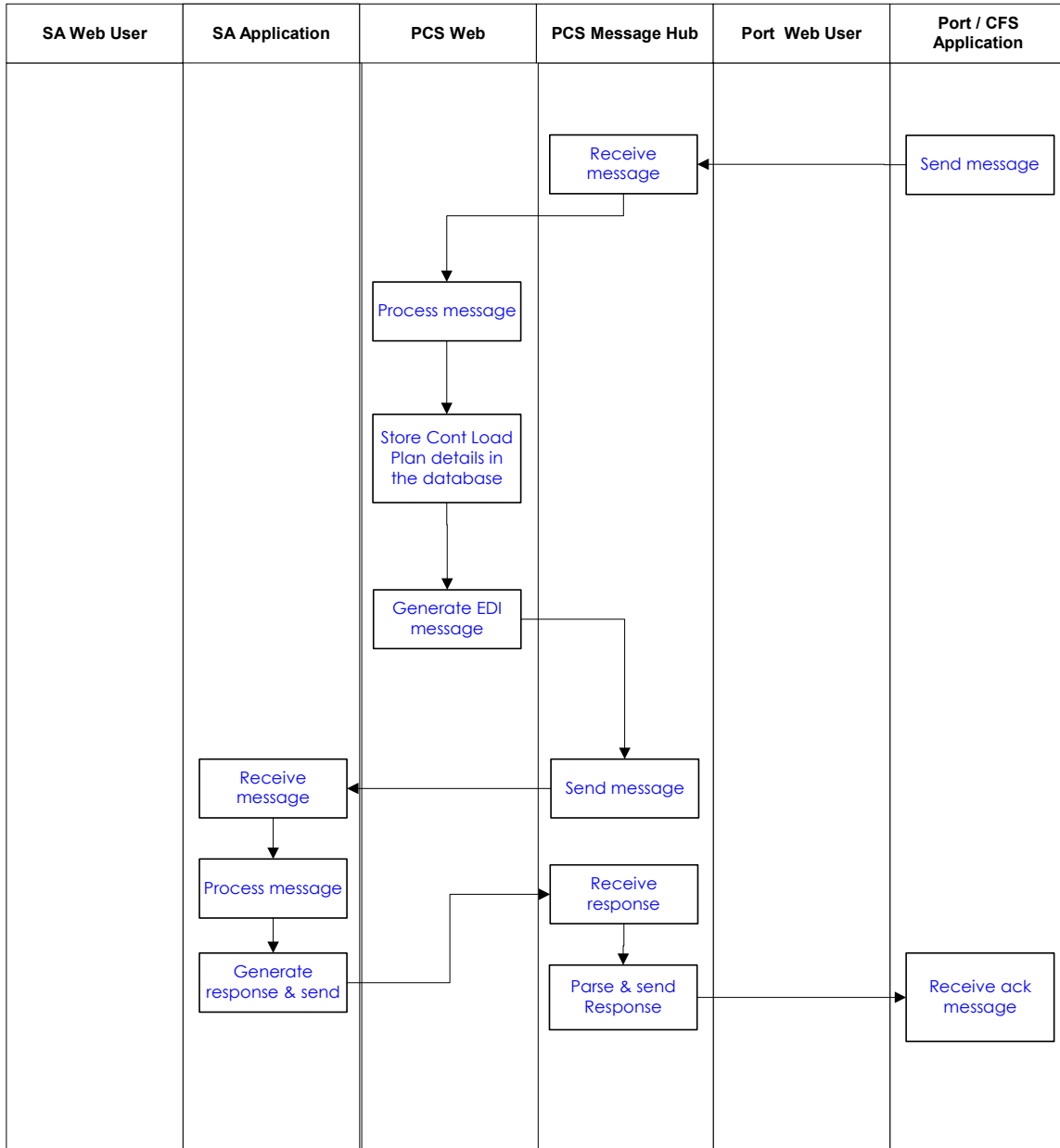

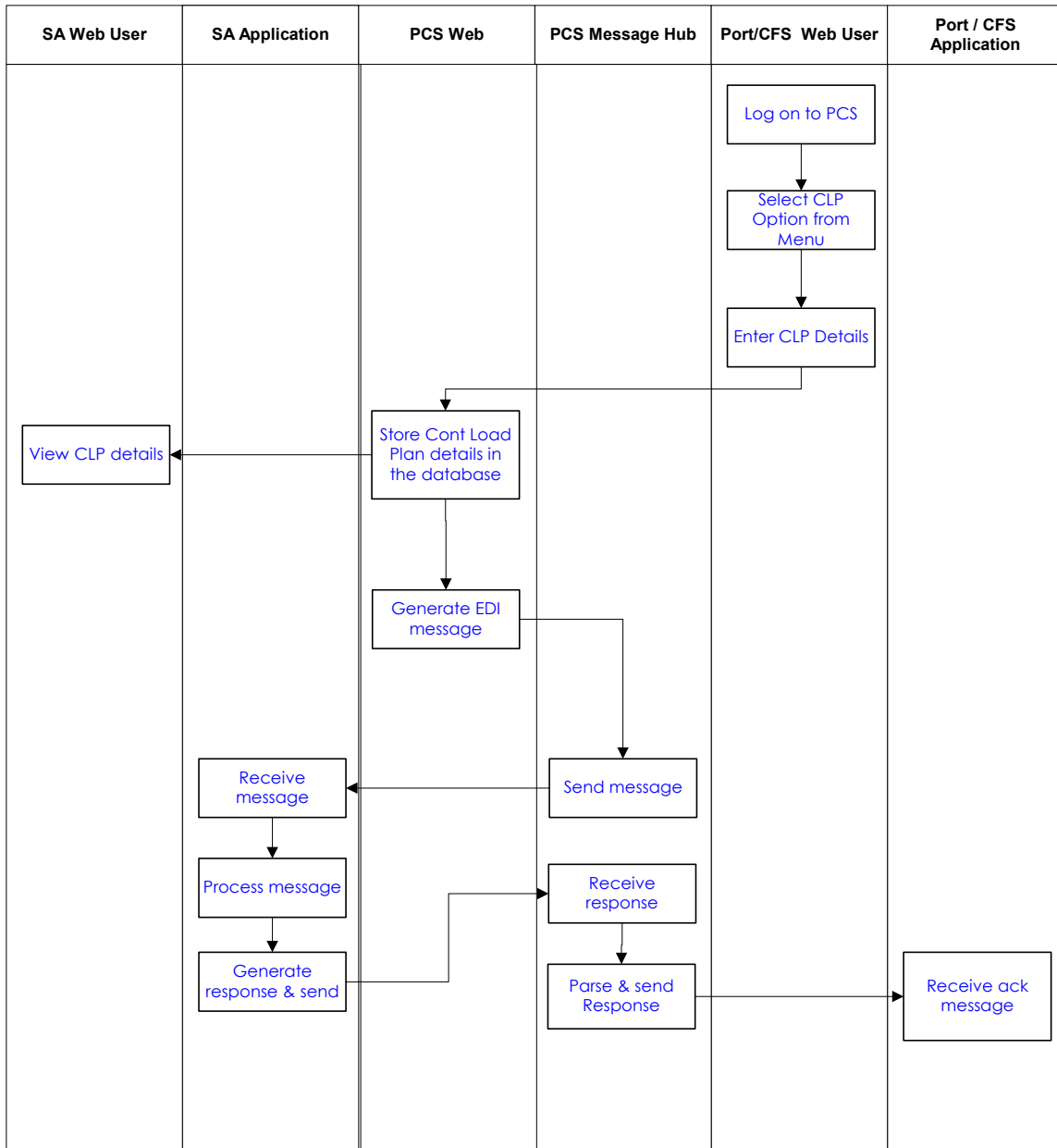

17. Container Special handling order

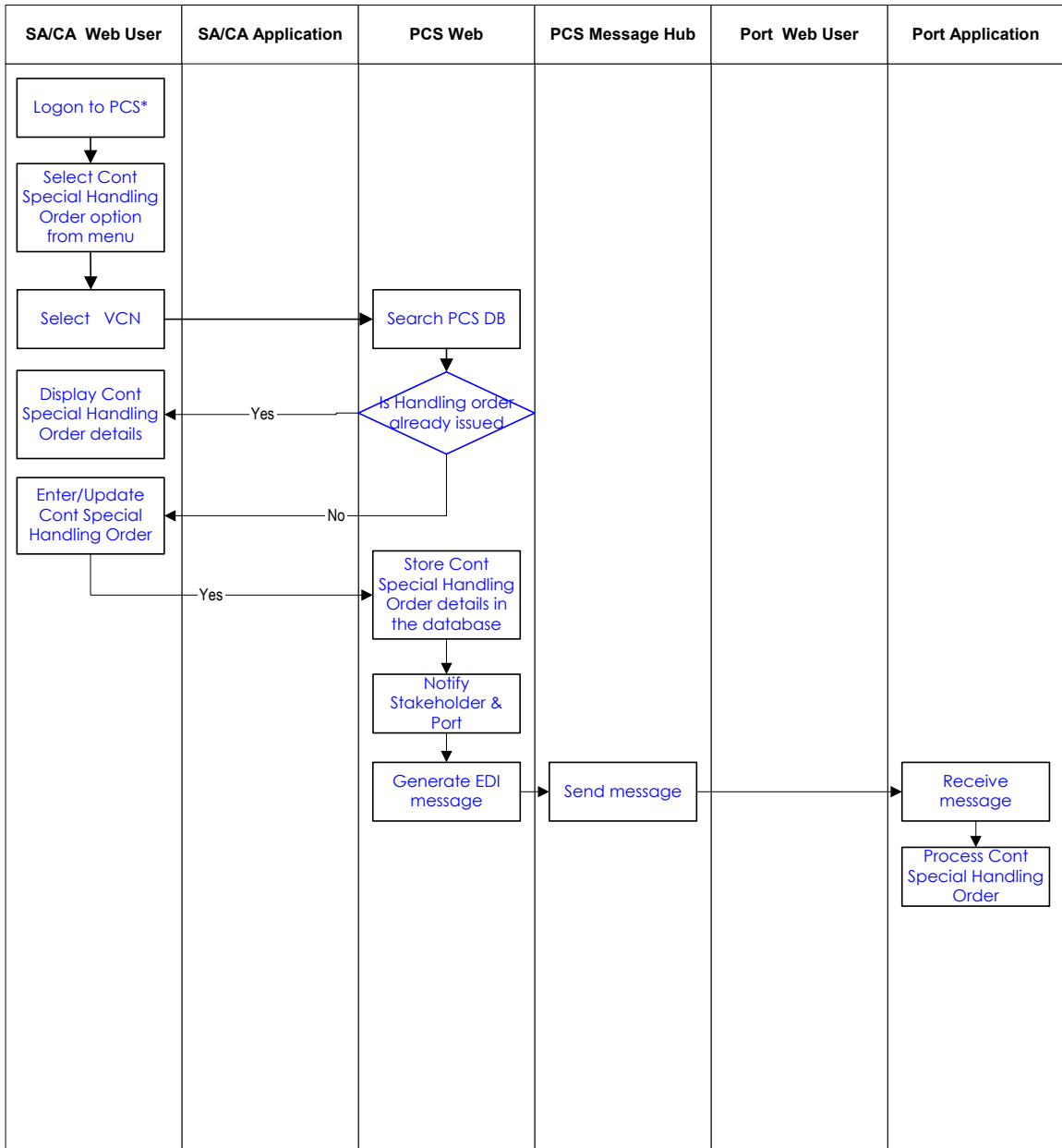

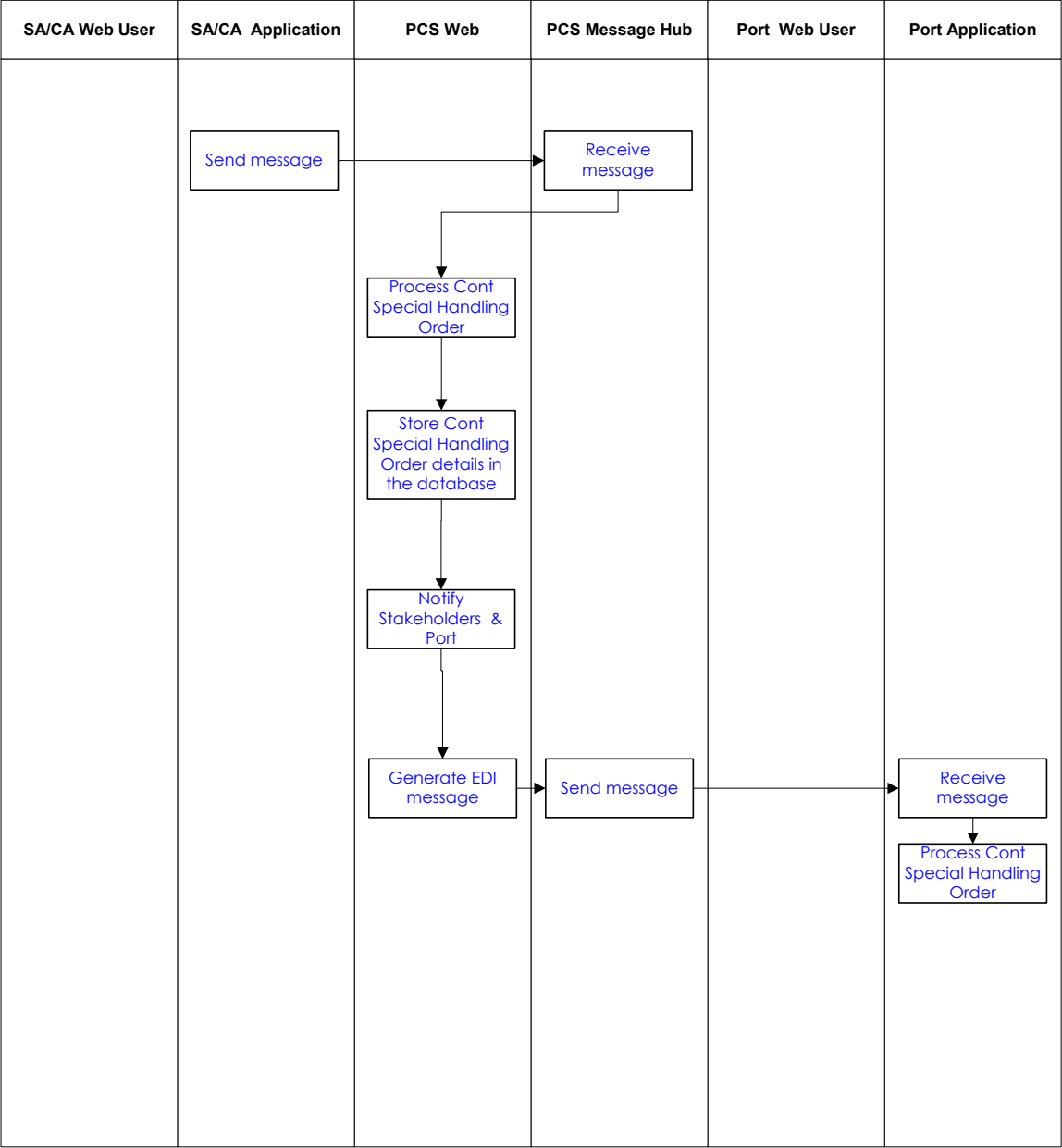

18. Container Stuffing/Destuffing Report

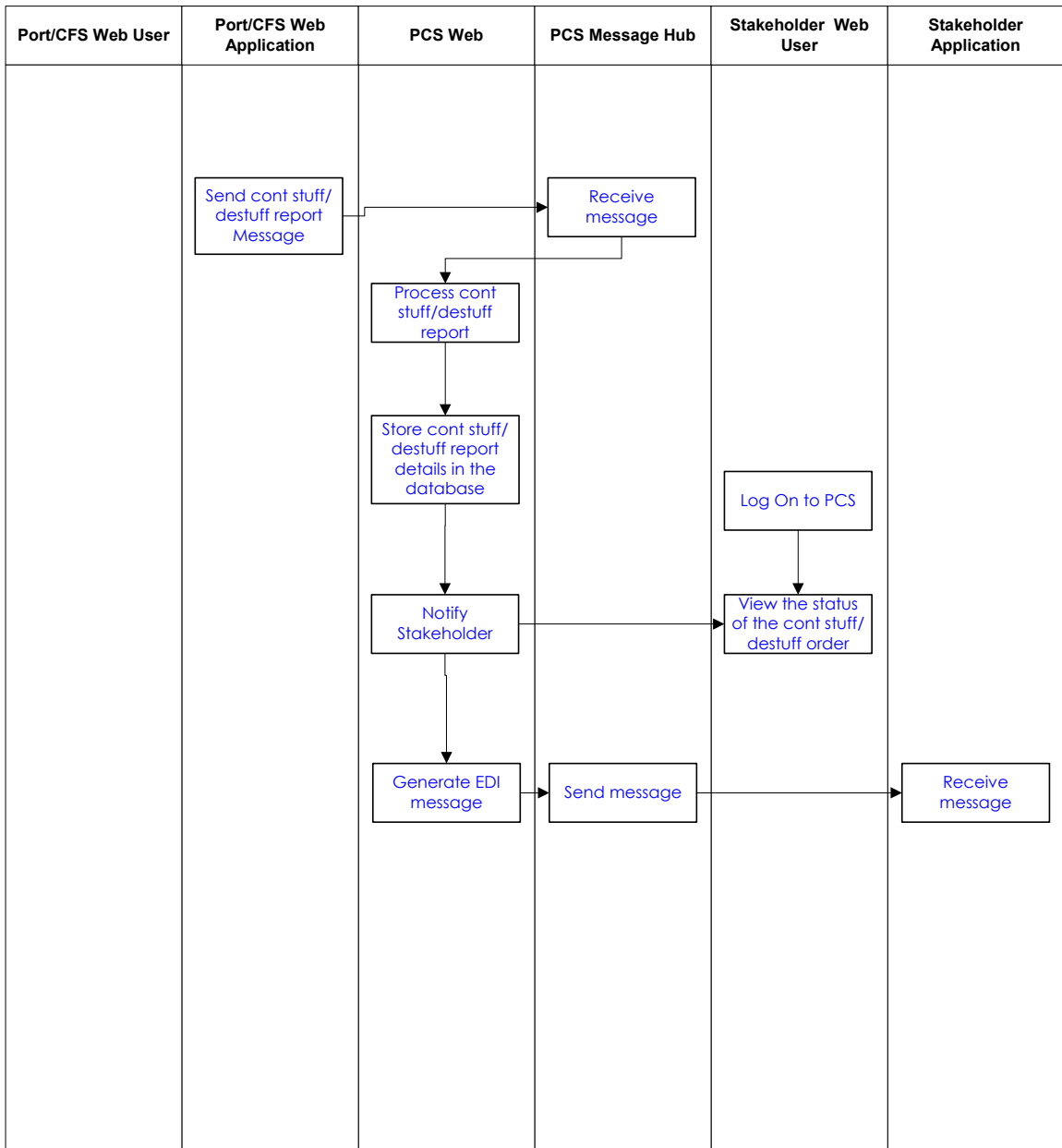

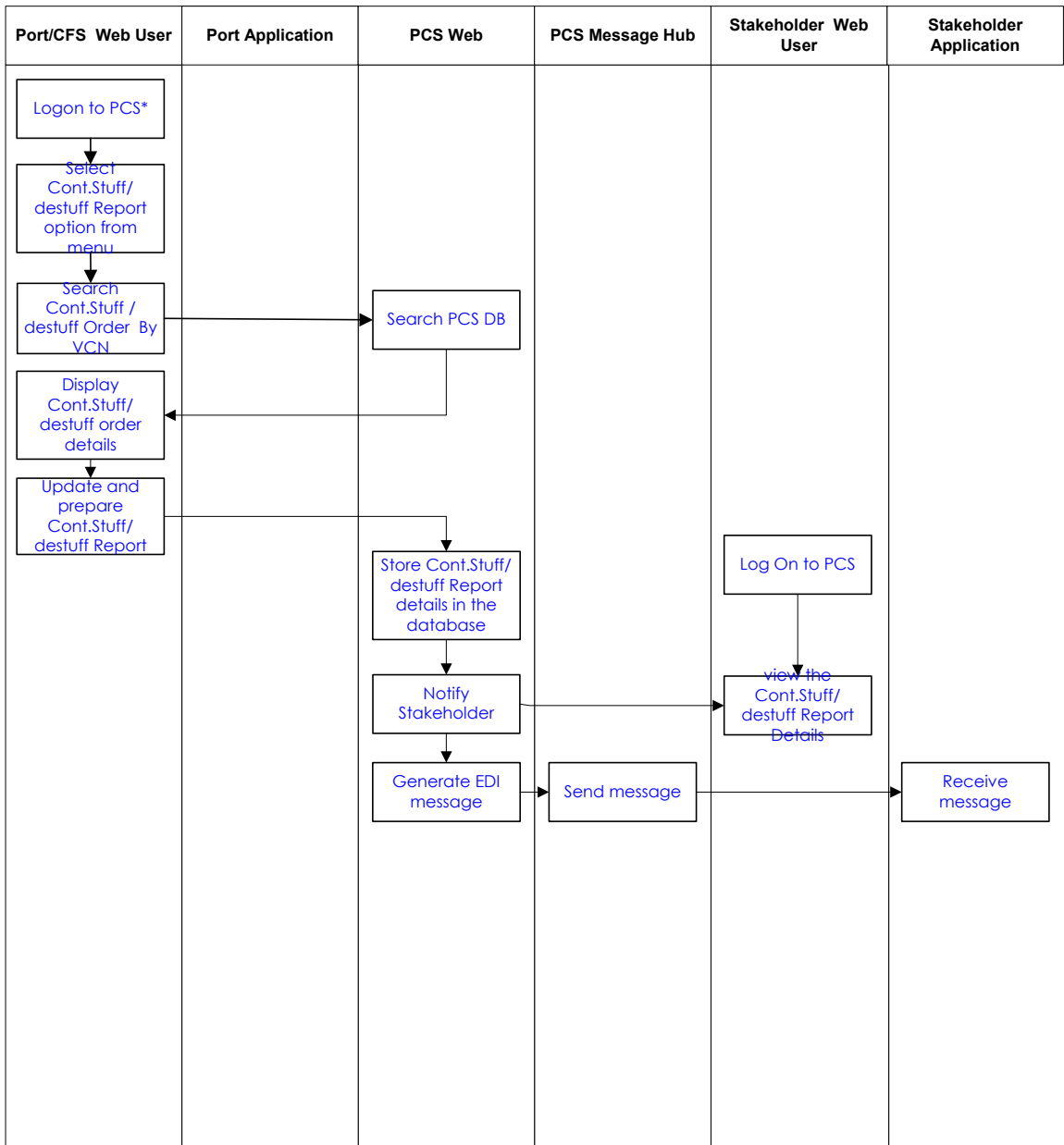

19. Gate Open/Cut off Report

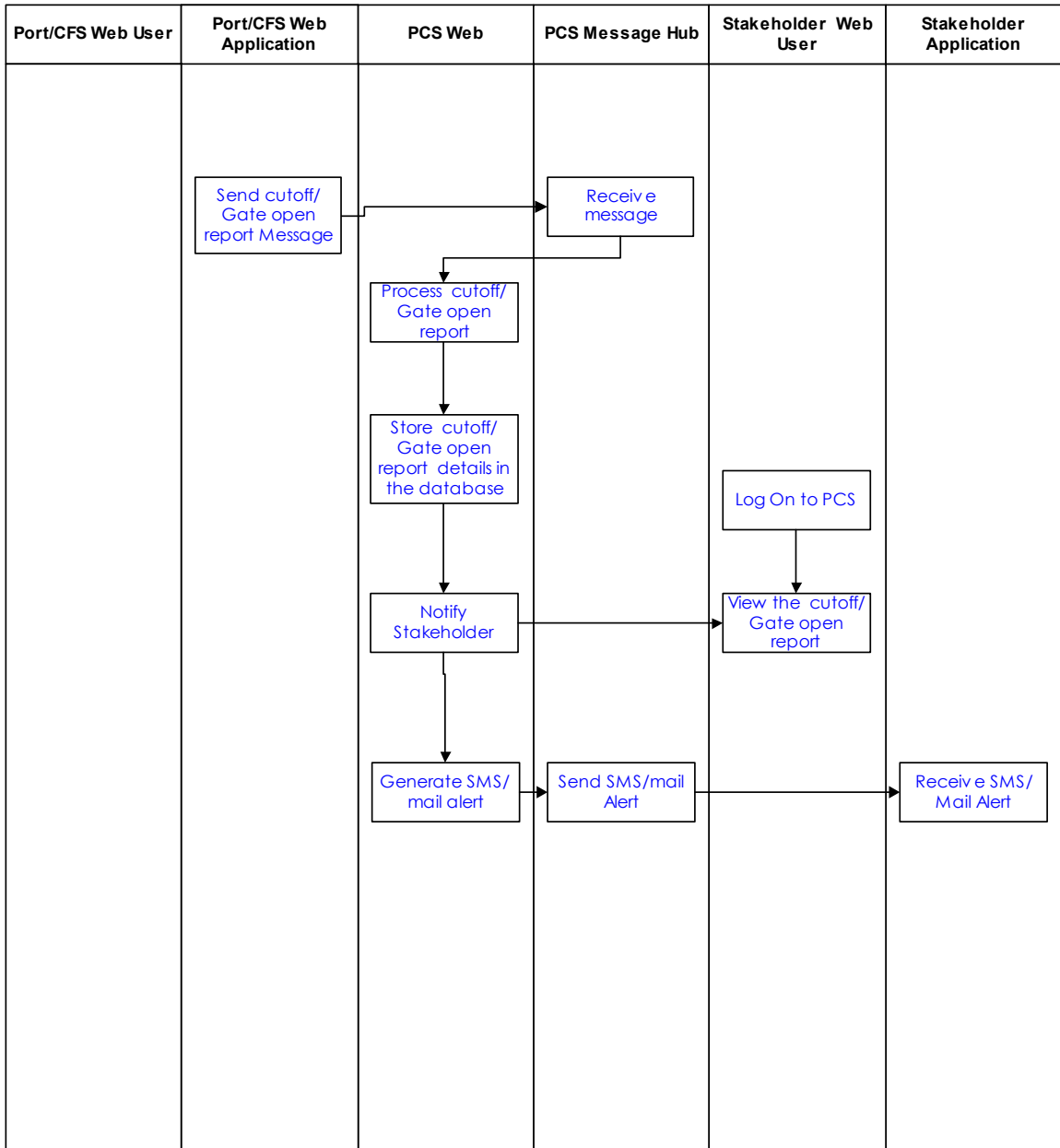

20. Cargo/Container Gate in/Gate out Report

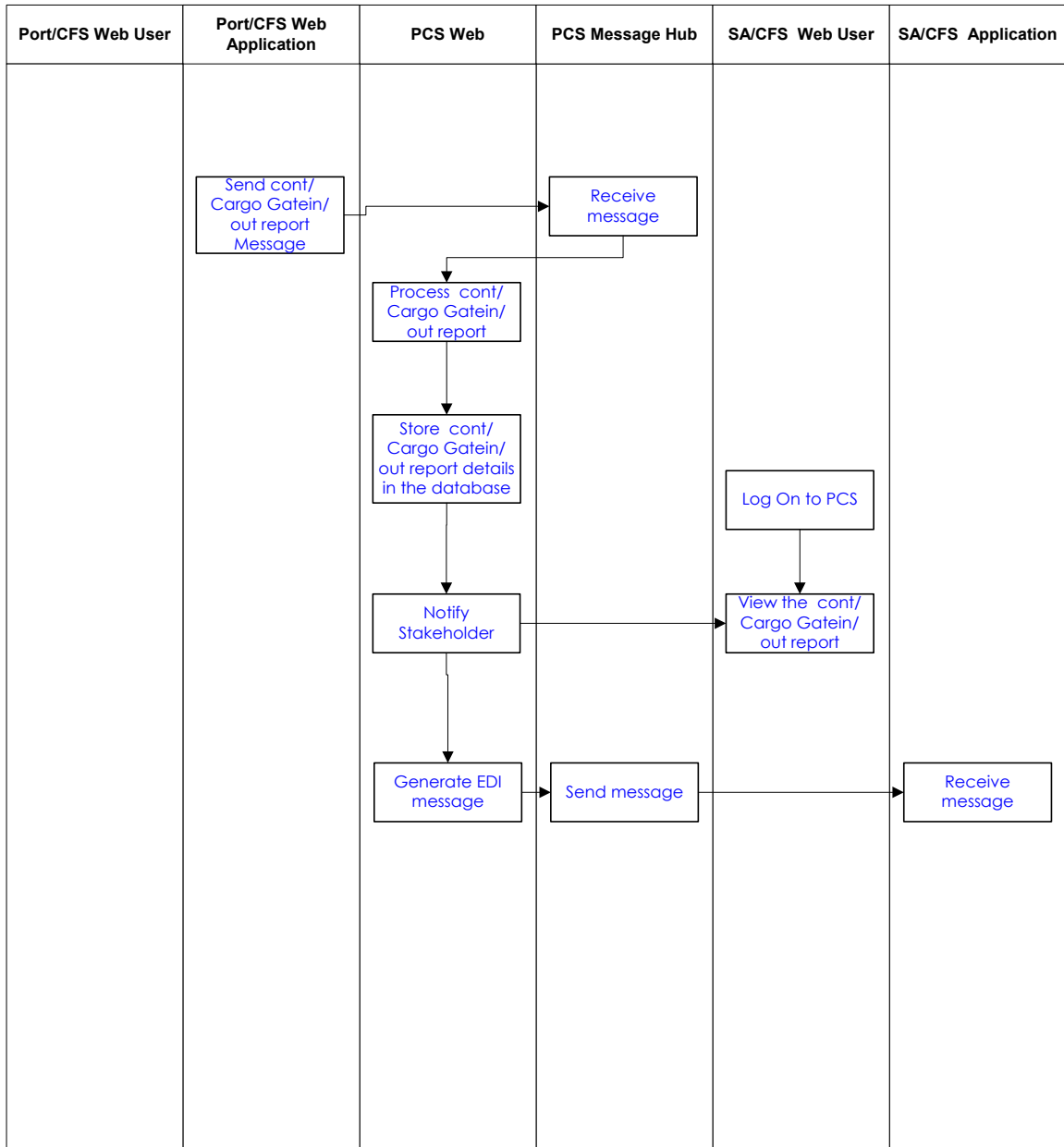

21. Equipment Interchange Report

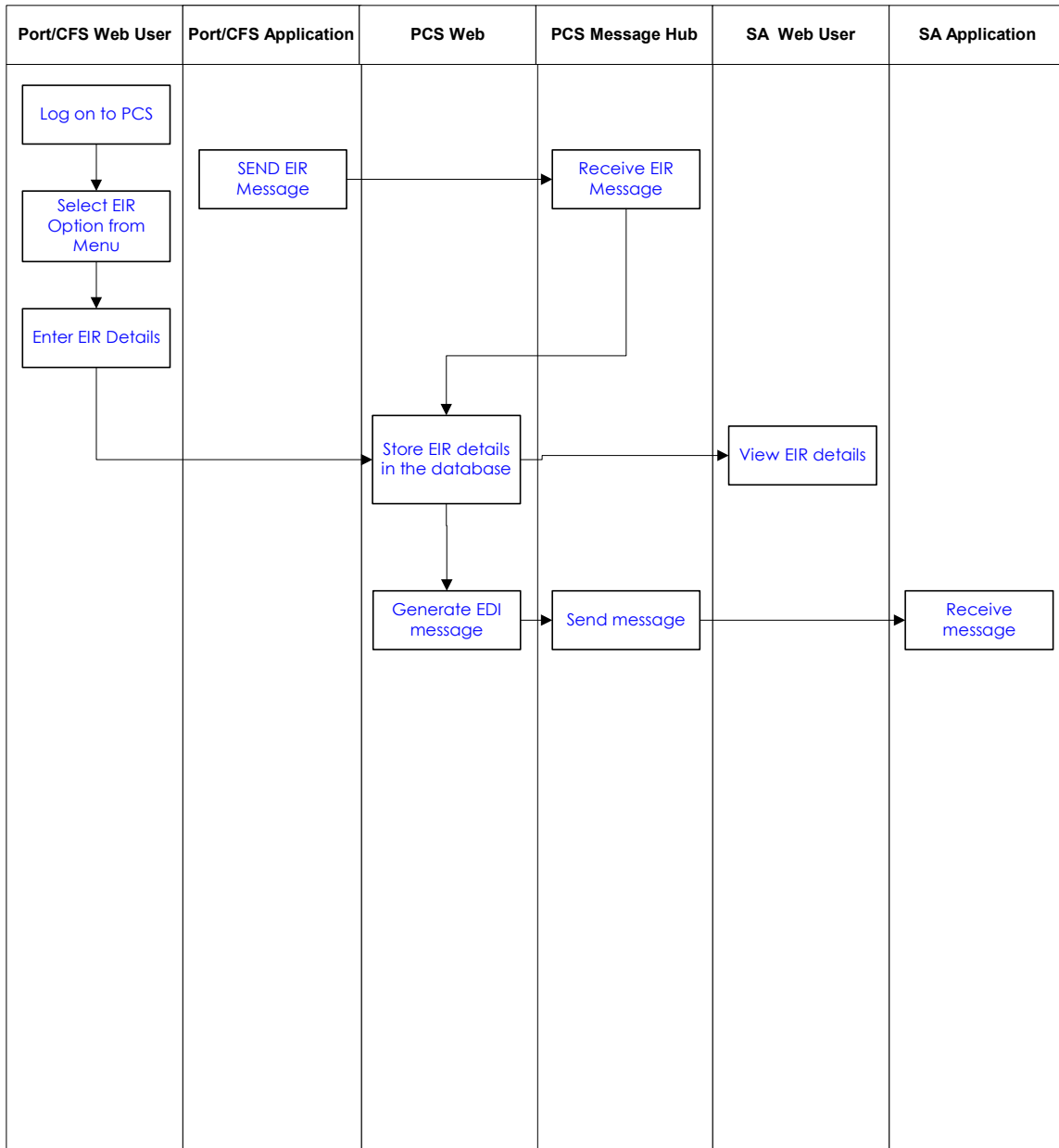

22. Empty Container Release Order

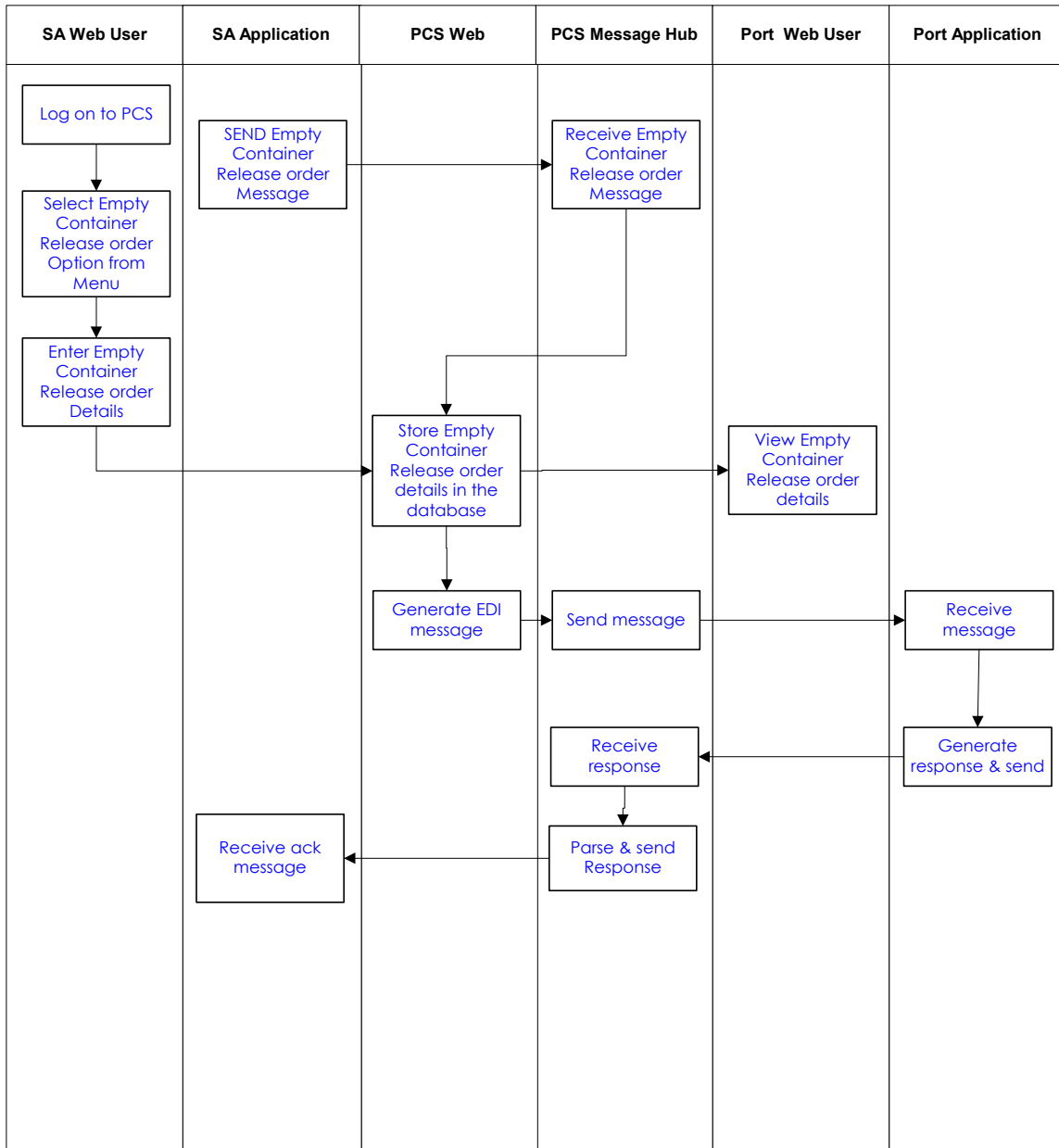

23. Container Stock Report

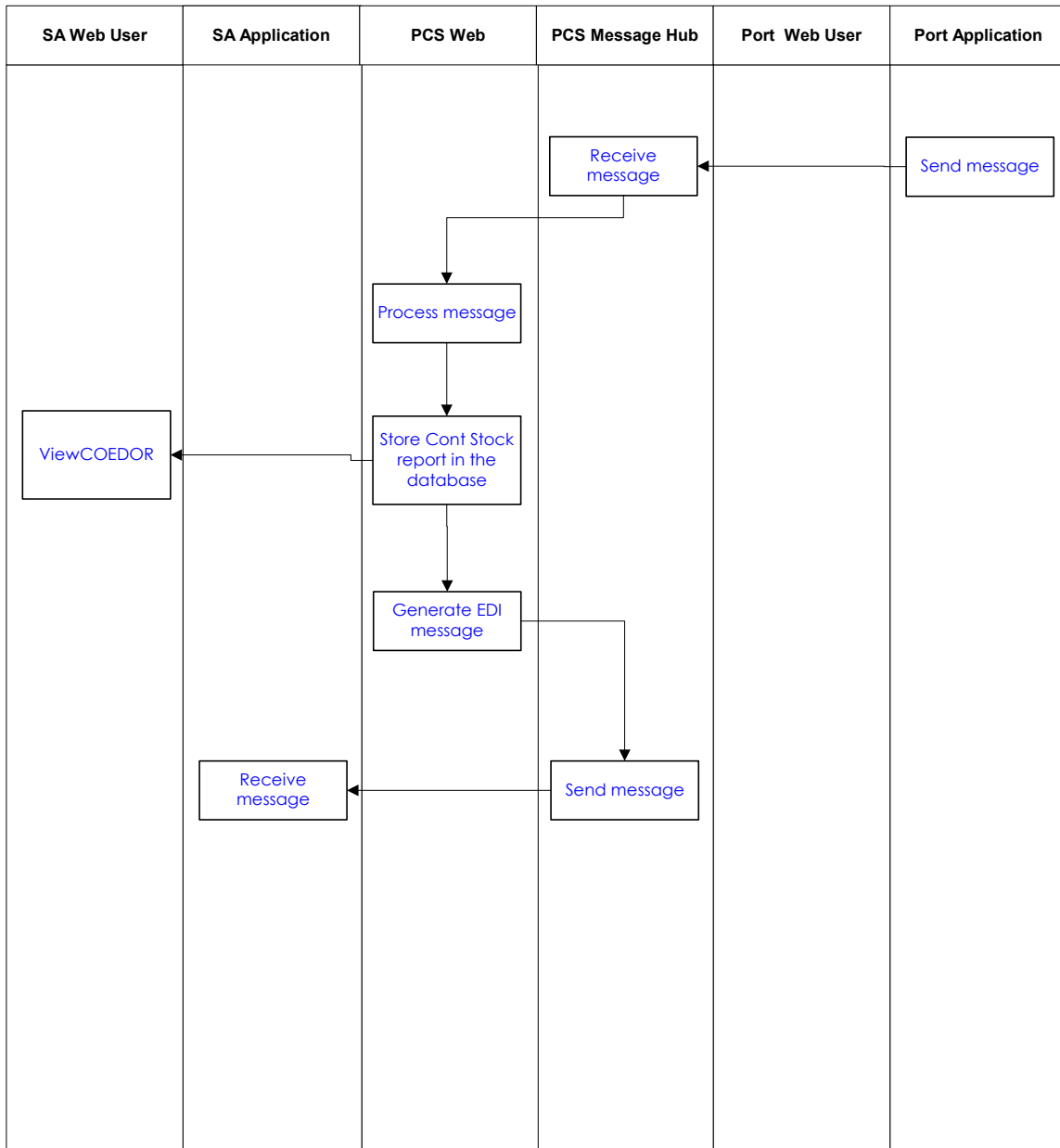

24. Request for Carting Permission

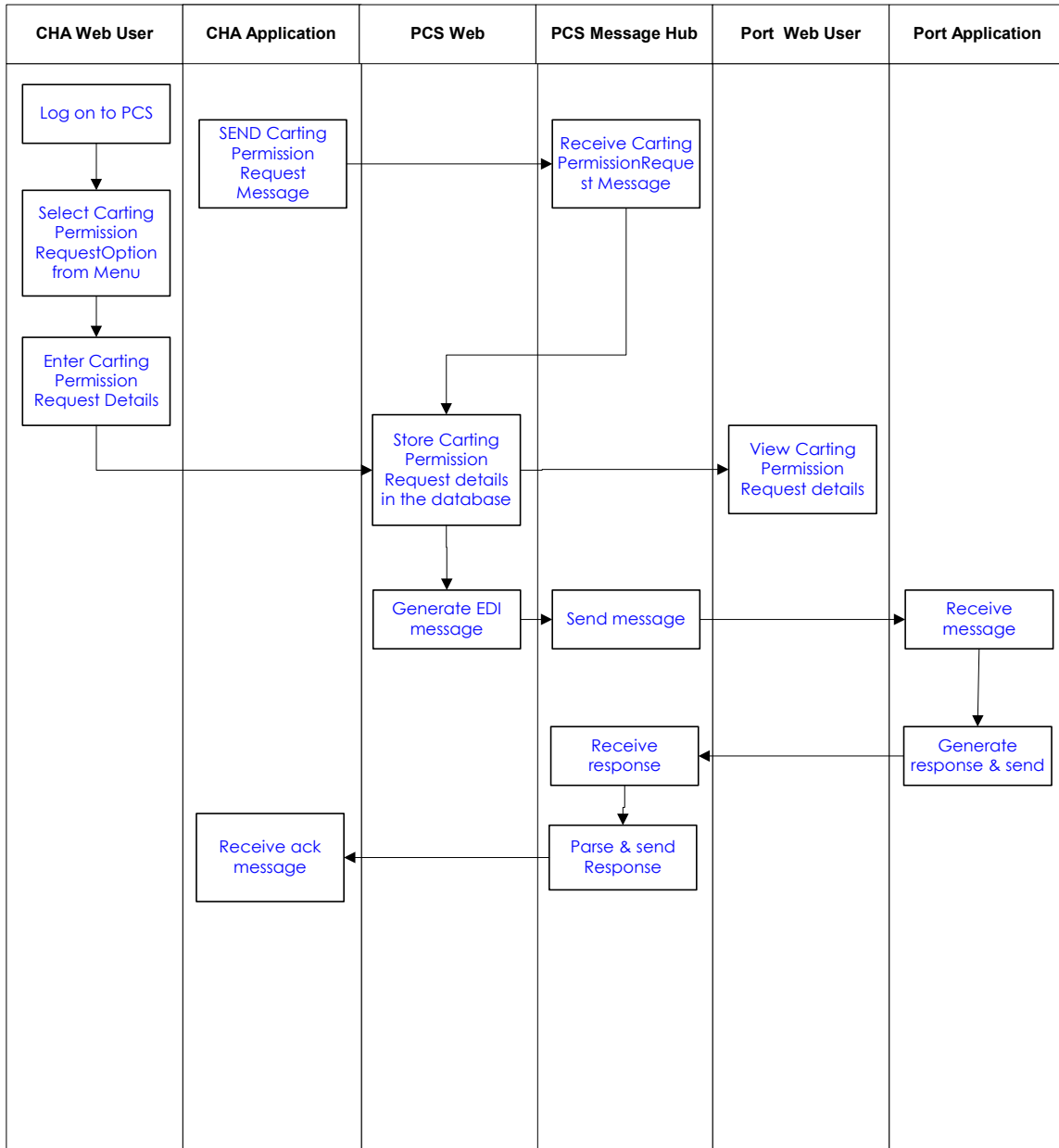

25. Confirmation of Carting

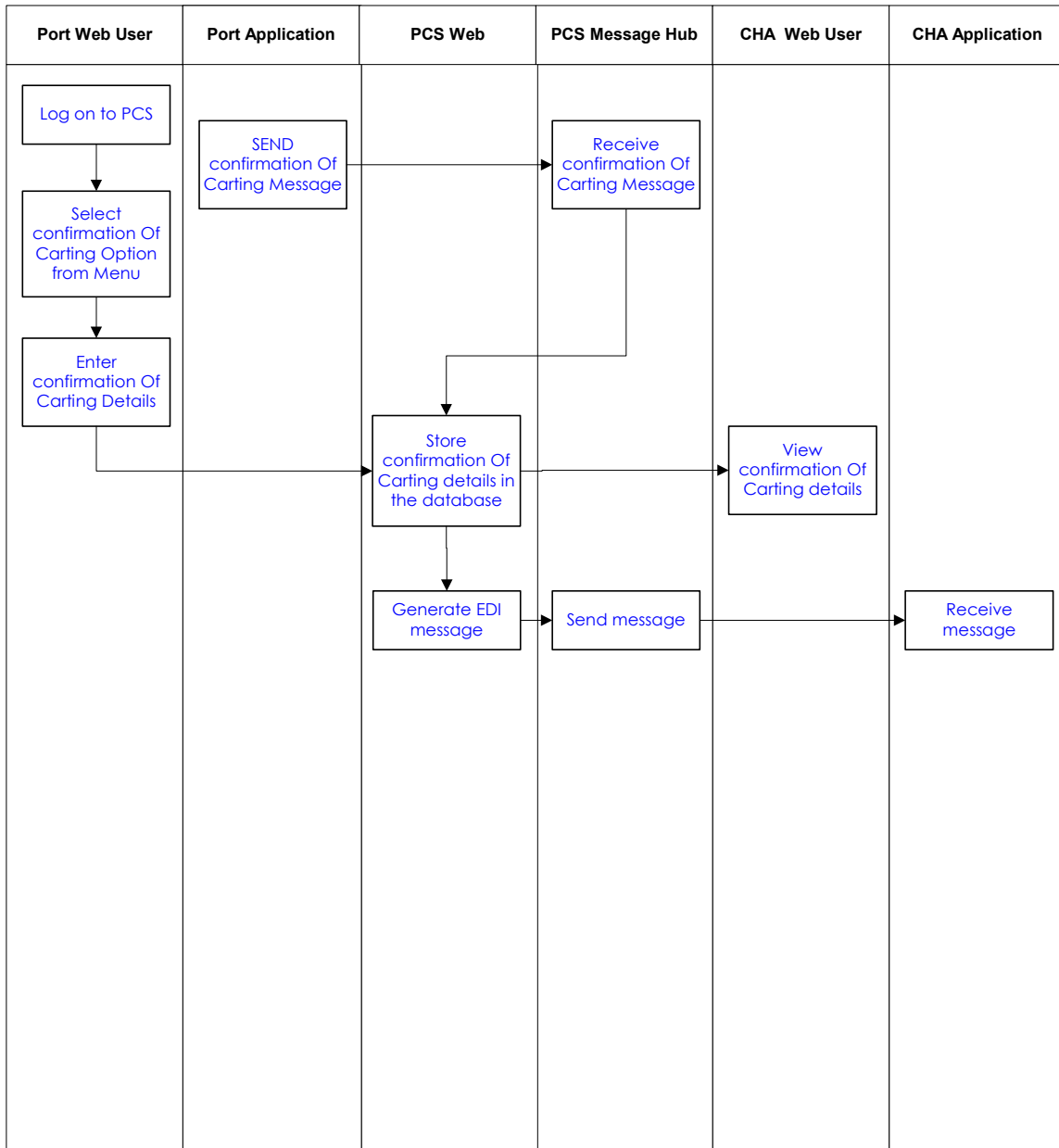

26. Job Order

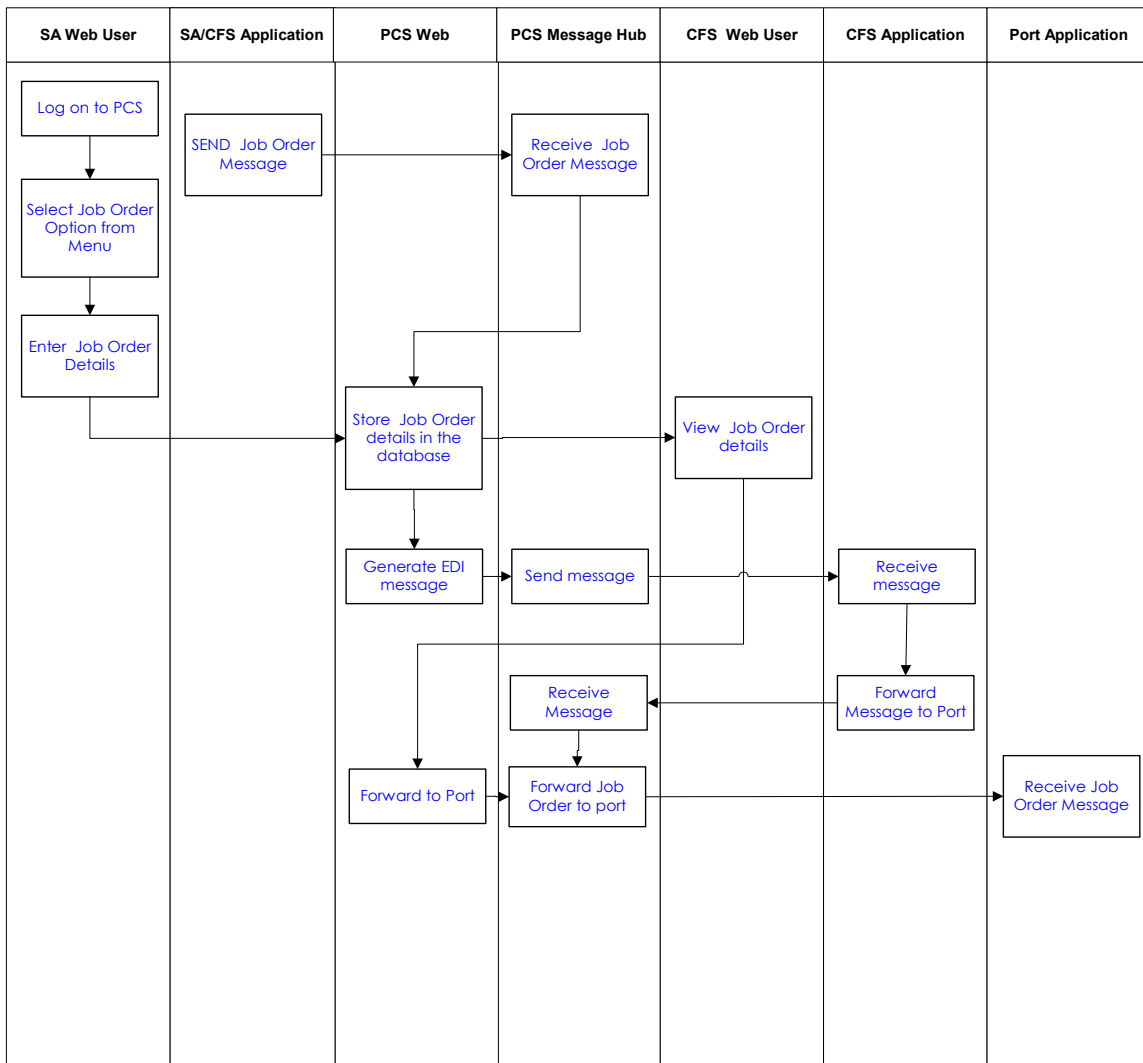

27. Assessment of charges

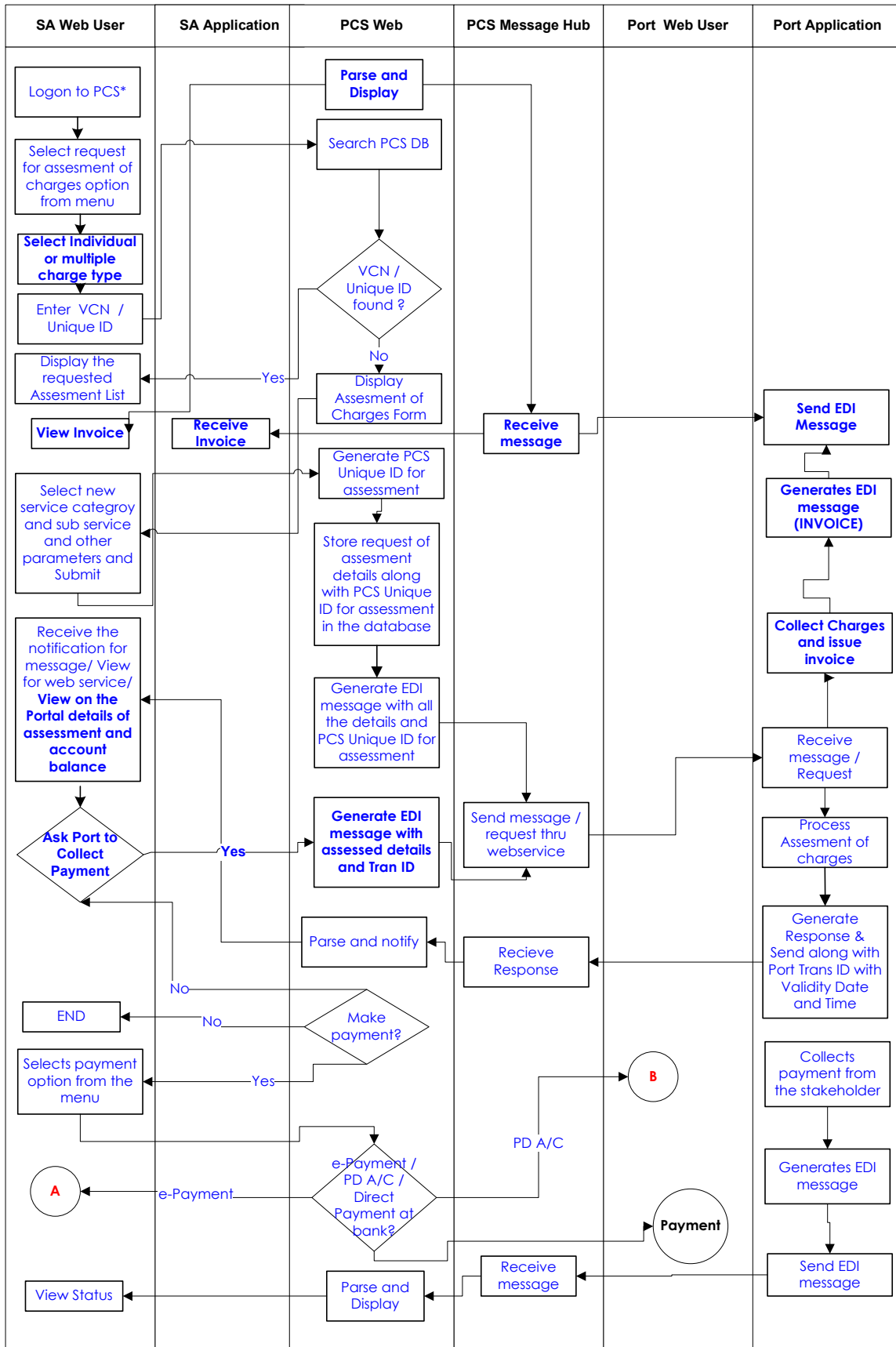

29. New PD Account

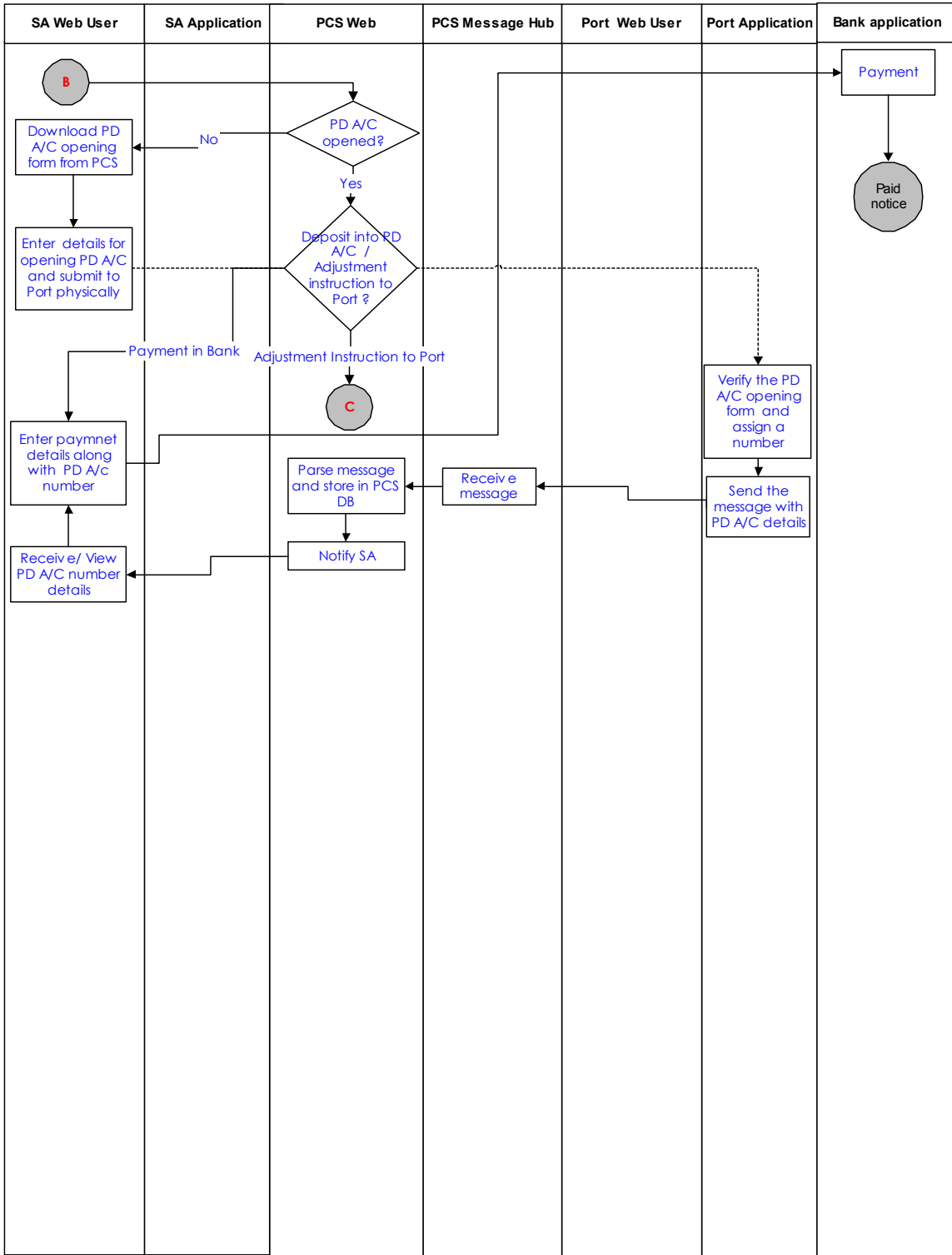

30. PD Account Payment

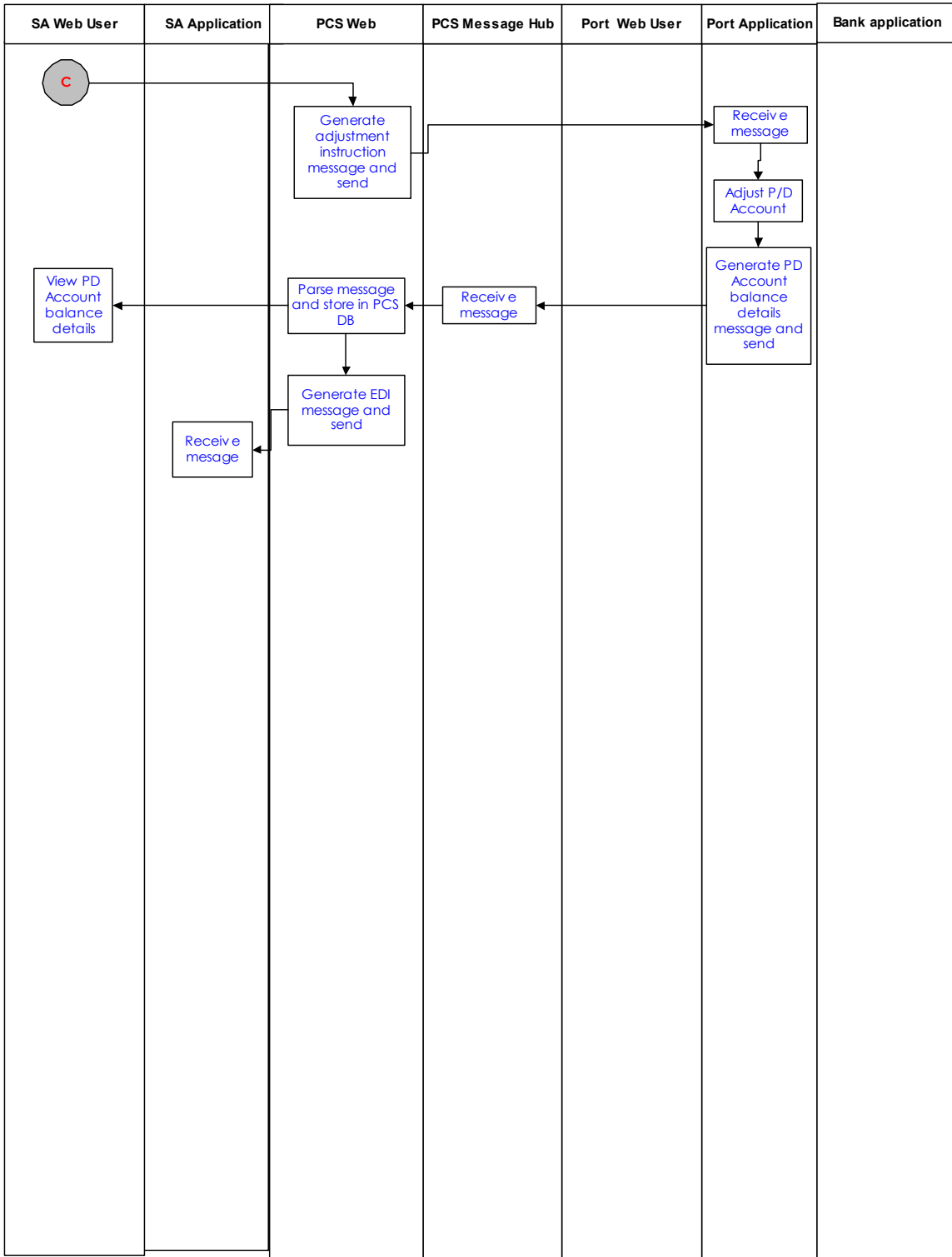

31. Invoice

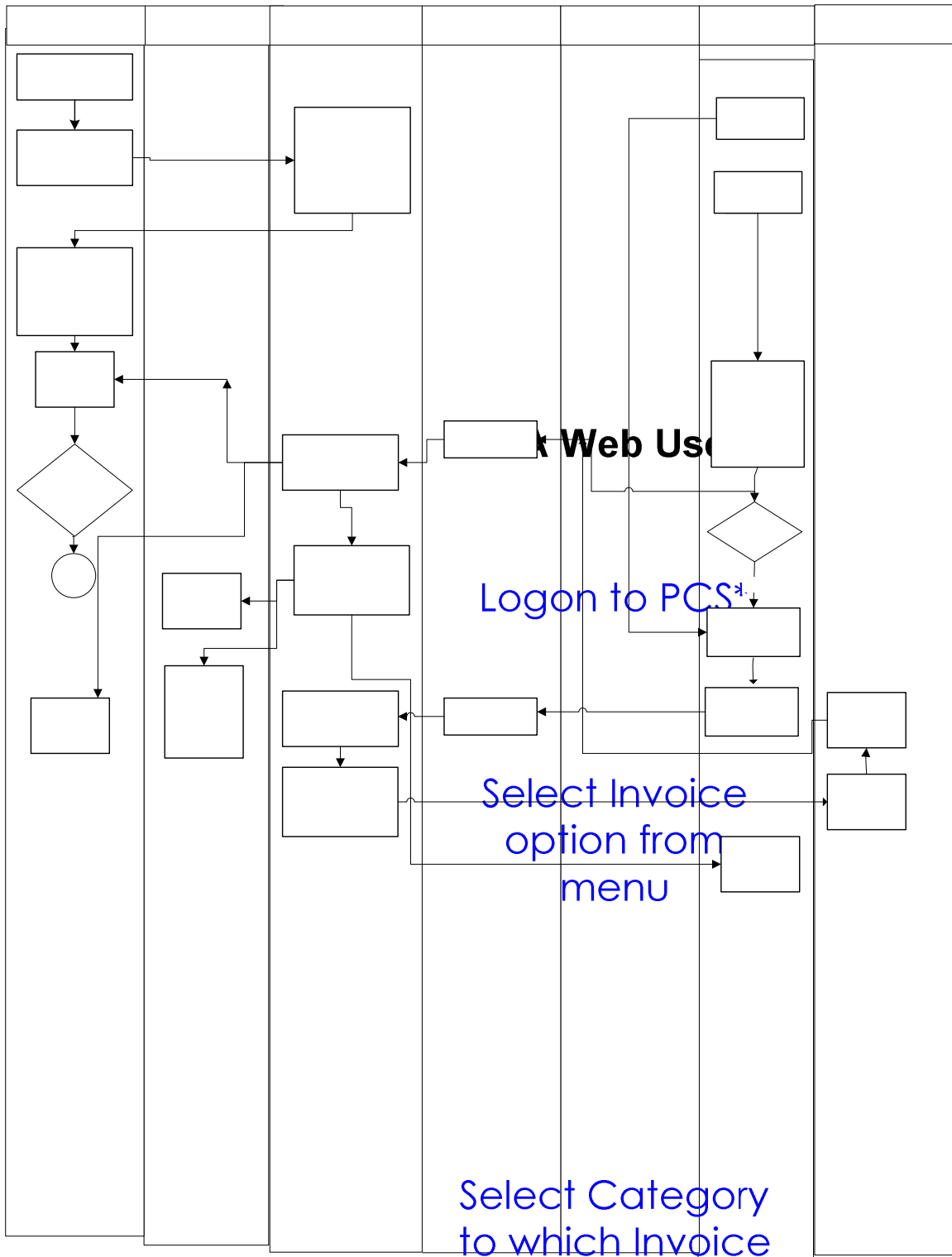

View Invoice details

32. Stakeholders Configuration

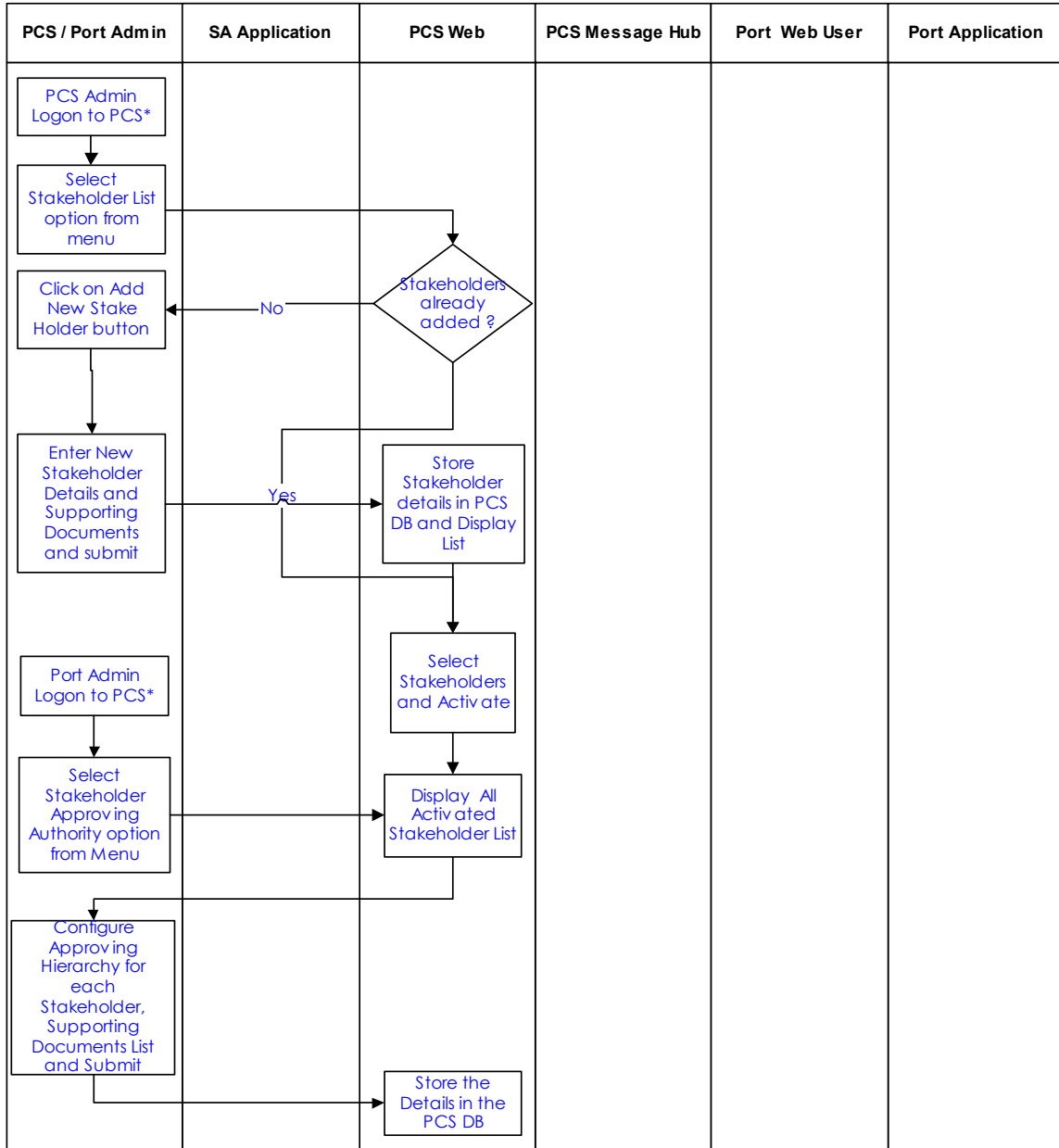

33. Stakeholders Registration

